

**City of Garden Grove**  
**WEEKLY CITY MANAGER'S MEMO**  
**November 29, 2018**

TO: Honorable Mayor and City Council Members      FROM: Scott C. Stiles, City Manager

**I. ITEMS FROM OTHER GOVERNMENTAL AGENCIES, OUTSIDE AGENCIES, BUSINESSES AND INDIVIDUALS**

- A.** Memorandum from Mr. Larry Dick and Mr. Wayne S. Osborne of the Municipal Water District of Orange County (MWDOC) outlining monthly water usage data figures, an estimate of Tier 2 volume for MWDOC, and selected water supply information.

• **OTHER ITEMS**

- SOCIAL MEDIA HIGHLIGHTS AND NEWSPAPER ARTICLES  
Copies of the week's social media posts and local newspaper articles are attached for your information.
- MISCELLANEOUS ITEMS  
Items of interest are included.



SCOTT C. STILES  
City Manager



## Memorandum

**DATE:** November 28, 2018  
**TO:** Member Agencies – MWDOC Divisions Two & Three  
**FROM:** Larry Dick, Director – Division Two  
Wayne S. Osborne, Director – Division Three  
**SUBJECT:** Monthly Water Usage Data, Tier 2 Projection & Water Supply Information

---

The attached figures show the recent trend of water consumption in Orange County (OC), an estimate of Imported Water Sales for MWDOC, and selected water supply information.

- OC Water Usage, Monthly by Supply OCWD Groundwater was the main supply in September.
- OC Water Usage, Monthly, Comparison to Previous Years Water usage in September 2018 was above average compared to the last 5 years. We are continuing to see slight increases in overall water usage compared to the previous three Fiscal Years. It has been 19 months since all mandatory water restrictions were lifted by the California State Water Resources Control Board.
- Historical OC Water Consumption Orange County M & I water consumption is estimated to be 555,000 AF in FY 2018-19 (*this includes ~15 TAF of agricultural usage and non-retail water agency usage*). This is about 15,000 AF more than FY 2017-18 and is about 36,000 AF more than FY 2016-17. Water usage per person is projected to be slightly higher in FY 2018-19 for Orange County at 153 gallons per day (This includes recycled water). Although OC population has increased 20% over the past two decades, water usage has not increased, on average. A long-term decrease in per-capita water usage is attributed mostly to Water Use Efficiency (water conservation) efforts. O.C. Water Usage for the last three Fiscal Years is the lowest since the 1982-83 Fiscal Year (FY1982-83 was the third wettest year on record).

Water Supply Information Includes data on Rainfall in OC; the OCWD Basin overdraft; Northern California and Colorado River Basin hydrologic data; the State Water Project (SWP) Allocation, and regional storage volumes. The data have implications for the magnitude of supplies from the three watersheds that are the principal sources of water for OC. Note that a hydrologic year is Oct. 1<sup>st</sup> through Sept. 30<sup>th</sup>.

- Orange County's accumulated rainfall through October was well below average for this period. Water year to date rainfall in Orange County is 0.77 inches, which is 118% of normal.
- Northern California accumulated precipitation through October was around 24% of normal for this period. Water Year 2018 was 82% of normal while water year 2017 was 187% of normal. The Northern California snowpack was 43% of normal as of April 1<sup>st</sup>. As of late October, 47.94% of California is experiencing moderate to extreme drought conditions while 84.84% of the state is experiencing abnormally dry conditions. The State Water Project Contractors Table A Allocation was set at 35% for 2018.
- Colorado River Basin accumulated precipitation through early November was 156% average for this period. The Upper Colorado Basin snowpack was 71% of normal as of April 3. Lake Mead and Lake Powell combined have about 57% of their average storage volume for this time of year and are at 41.4% of their total capacity. If Lake Mead's level falls below a "trigger" limit 1,075 ft. at the end of a calendar year, then a shortage will be declared by the US Bureau of Reclamation (USBR), impacting Colorado River water deliveries to the Lower Basin states. As of late October, Lake Mead levels were 3.23' above the "trigger" limit. The USBR predicts that the start of 2019 will not hit the "trigger" level but there is a 57% chance that the trigger level will be hit in 2020 and a 68% chance in 2021.



**Fig. 1 OC Water Usage, Monthly by Supply with projection to end of fiscal year**

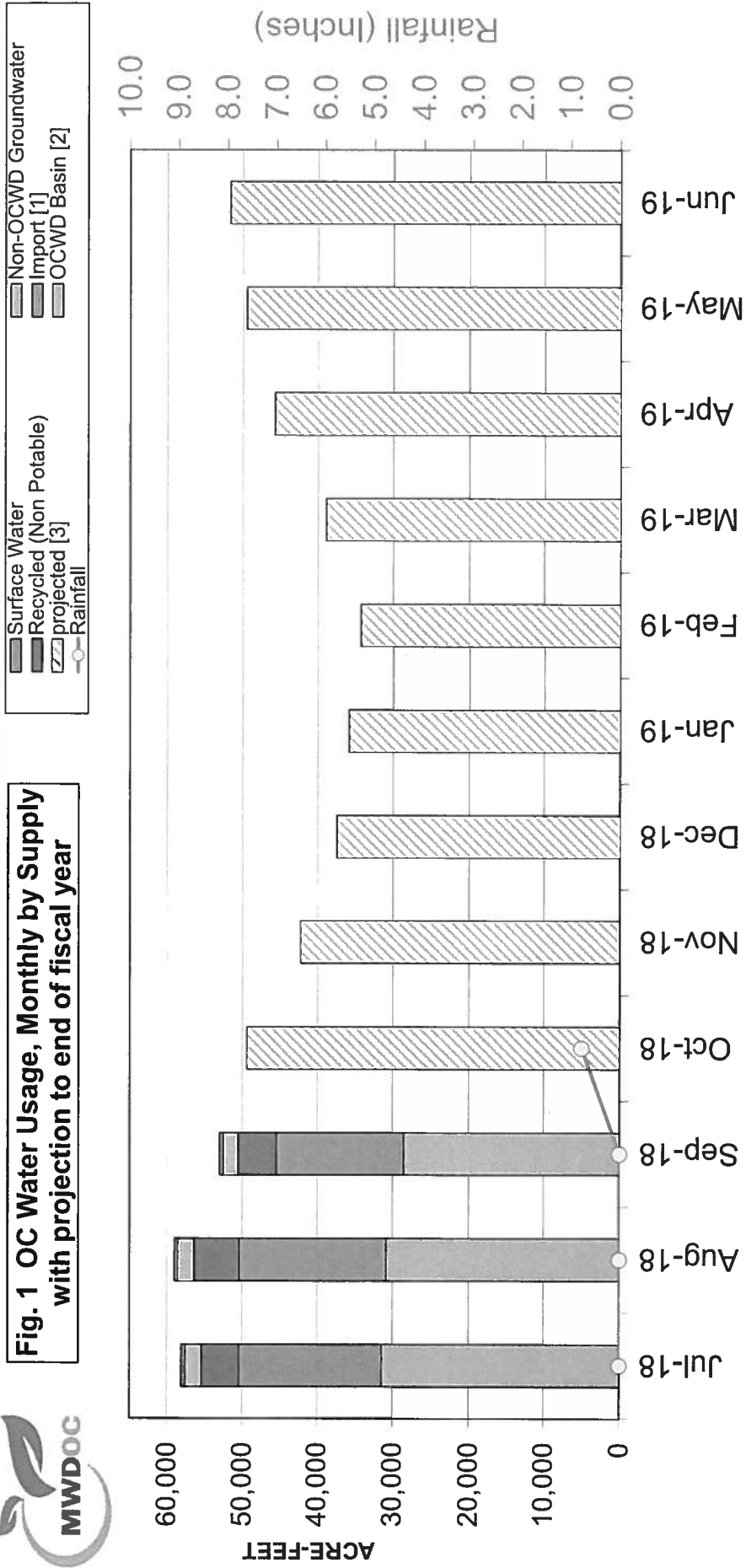

[1] Imported water for consumptive use. Includes "In-Lieu" deliveries and CUP water extraction. Excludes "Direct Replenishment" deliveries of spreading water, "Barrier Replenishment" deliveries, and deliveries into Irvine Lake.  
 [2] GW for consumptive use only. Excludes In-Lieu water deliveries and CUP water extraction that are counted with Import. BPP in FY '17-18 is 75%.  
 [3] MWD OC's estimate of monthly demand is based on the projected FY 15-16 "Retail" water demand and historical monthly demand patterns.  
 [4] Total water usage includes IRWD groundwater agricultural use and usage by non-retail water agencies.



**Fig. 2 OC Monthly Water Usage [1]: Comparison to Last 4 Fiscal Years**

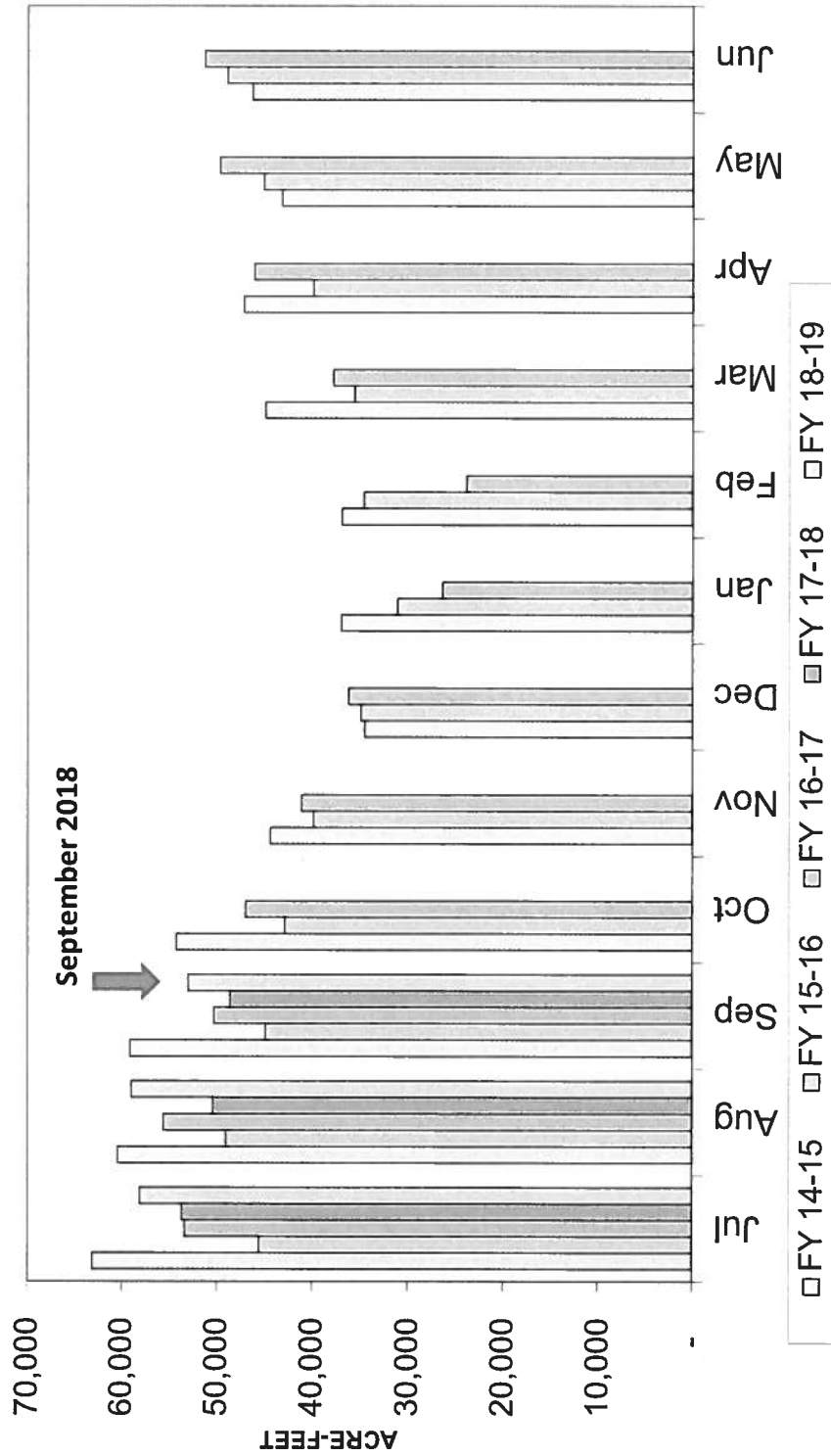

**Partial Year Subtotals**

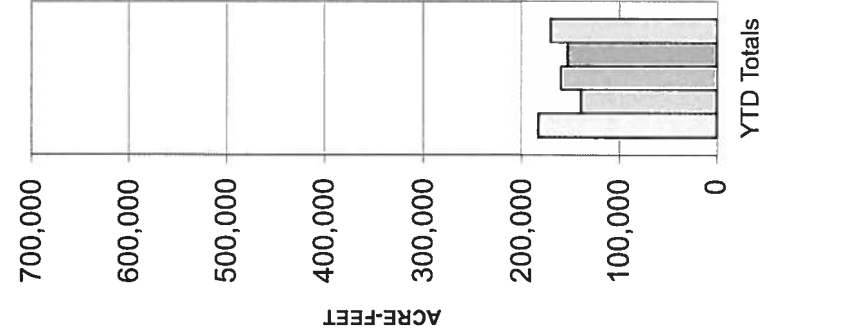

[1] Sum of Imported water for consumptive use (includes "In-Lieu" deliveries; excludes "Direct Replenishment" and "Barrier Replenishment") and Local water for consumptive use (includes recycled and non-potable water and excludes GWRs production) Recent months numbers include some estimation.

# Accumulated Precipitation

for the Oct.-Sep. water year, through early November 2018

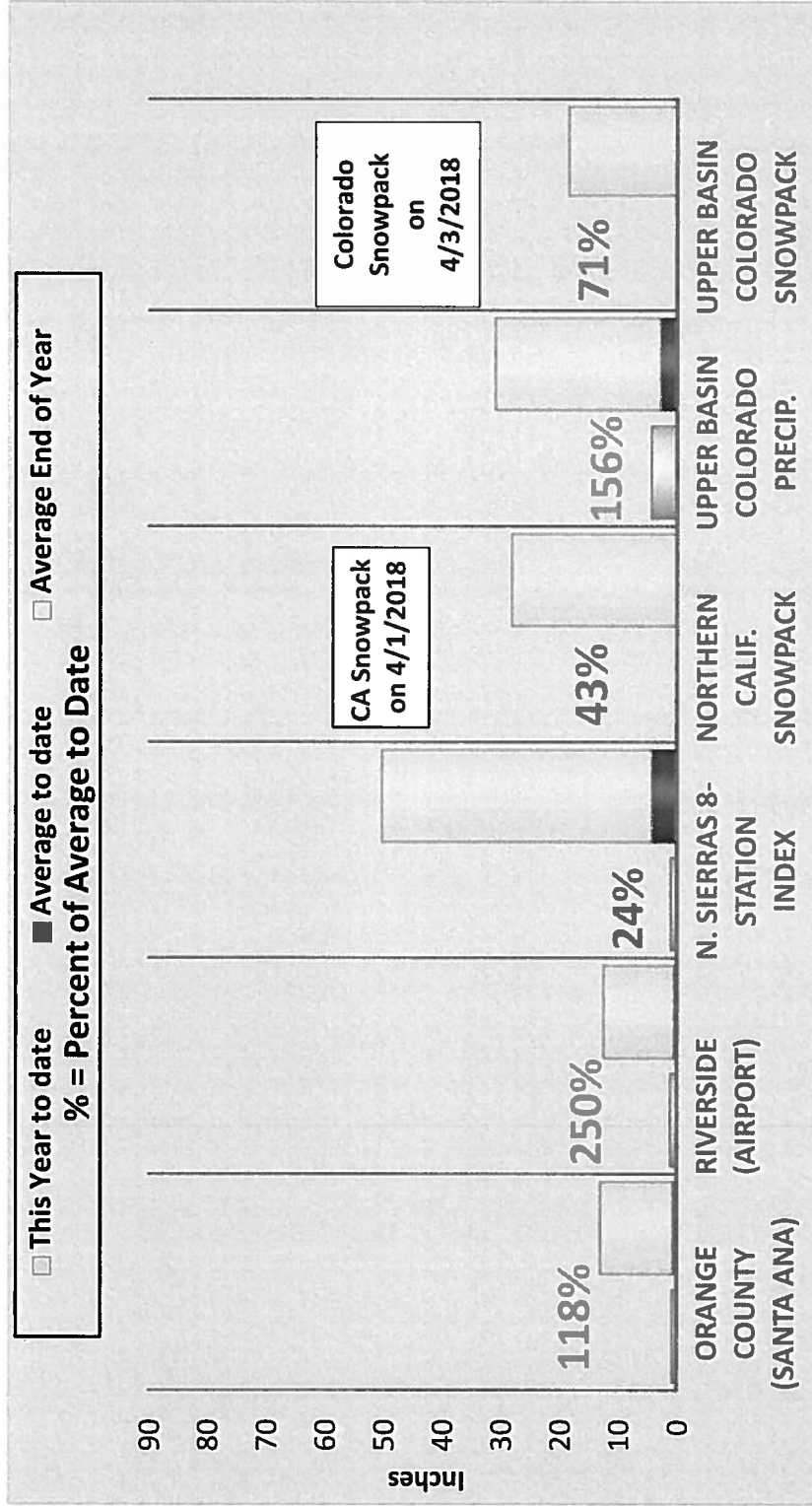

\* The date of maximum snowpack accumulation (April 1st in Northern Calif. , April 15th in the Upper Colorado Basin) is used for year to year comparison.

**State Water Project, Colorado River, and MWD Reservoir Storage**  
as of October 29, 2018

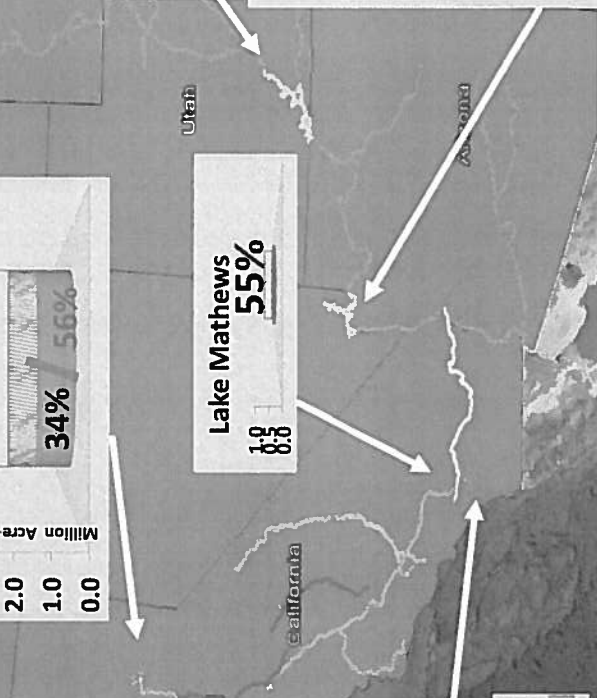
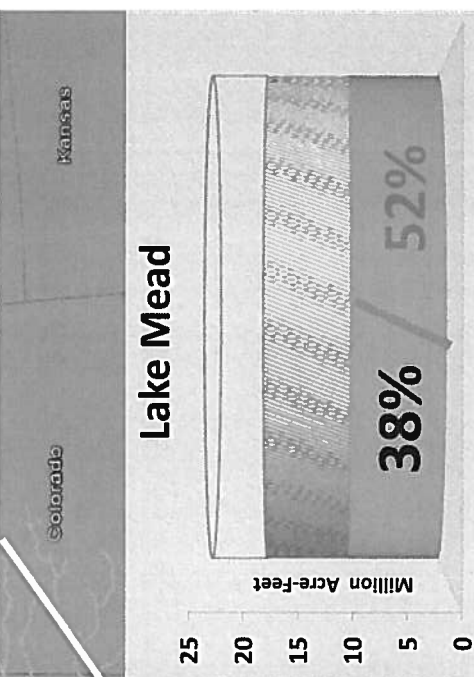
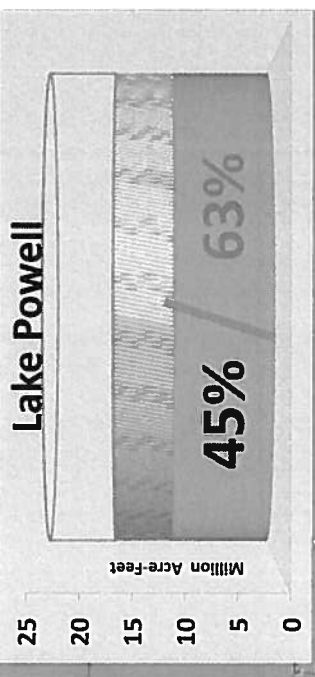
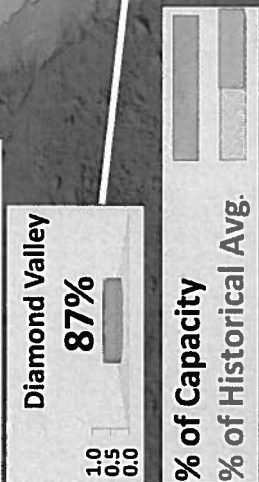
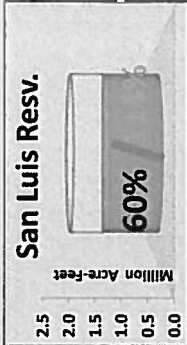
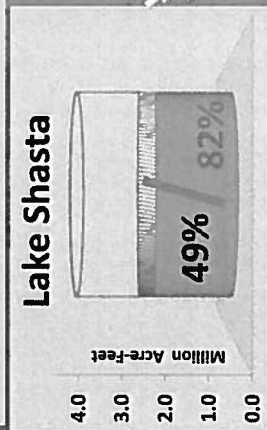

Prepared by the Municipal Water District of Orange County  
Numbers are Subject to Change



# SWP TABLE A ALLOCATION

FOR STATE WATER PROJECT CONTRACTORS

Final 2019: ???

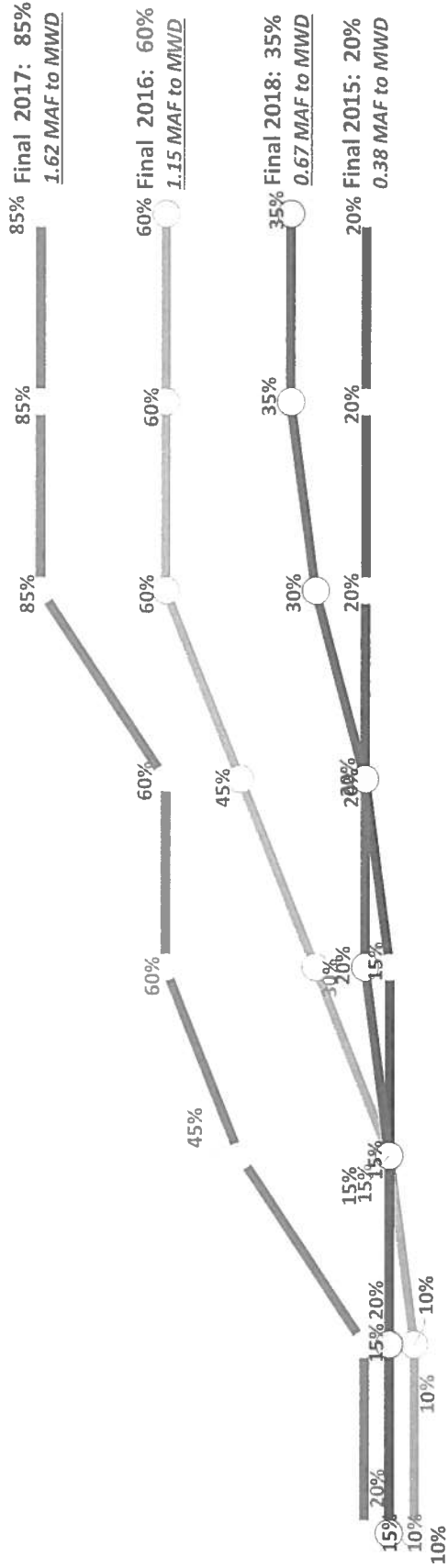

Water Year 2015
  Water Year 2016
  Water Year 2017
  Water Year 2018
  Water Year 2019



# Accumulated Overdraft of the OCWD Groundwater Basin as of September 2018

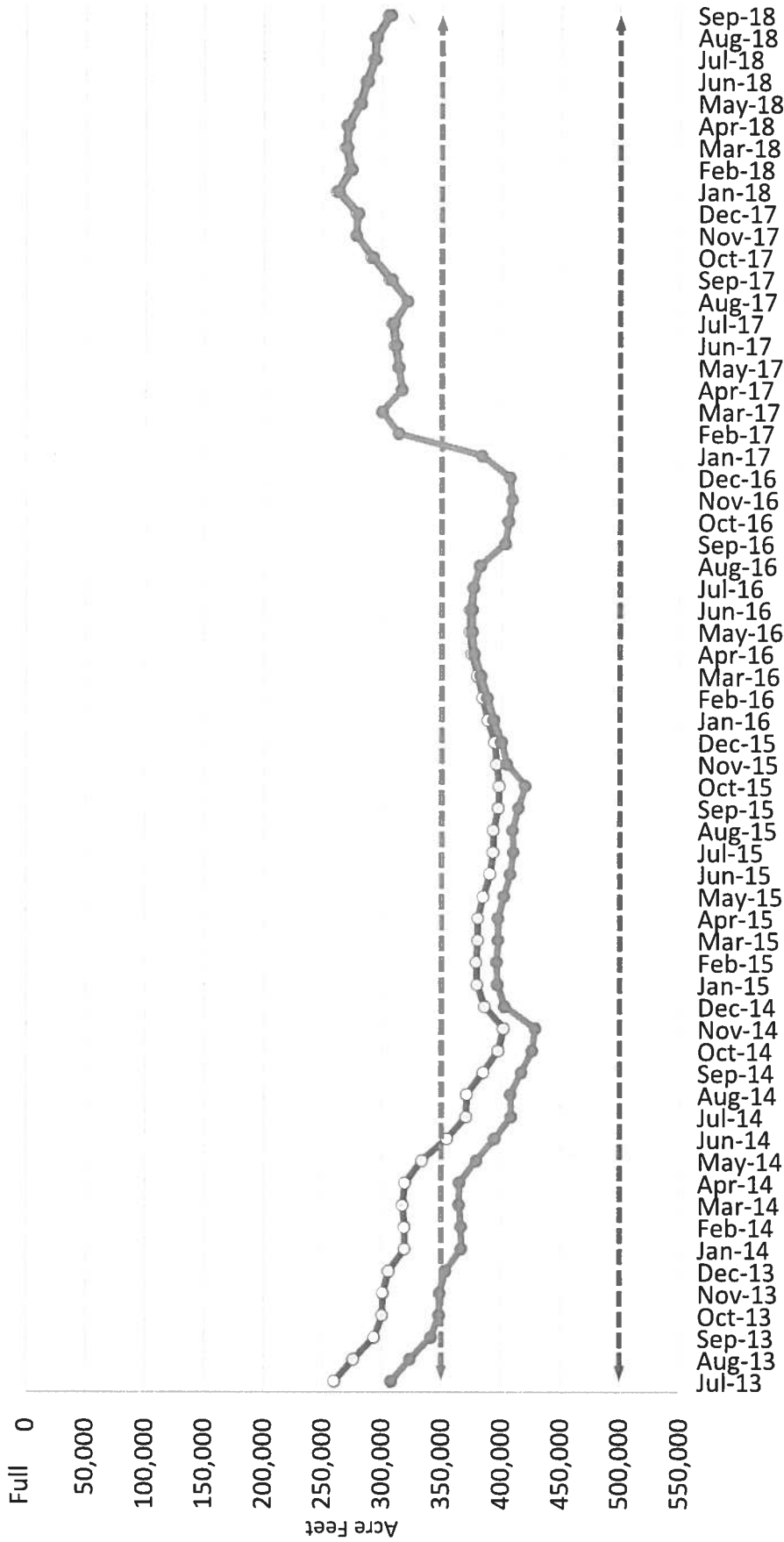

	Jul-17	Aug-17	Sep-17	Oct-17	Nov-17	Dec-17	Jan-18	Feb-18	Mar-18	Apr-18	May-18	Jun-18
AO (AF)	308,488	321,131	306,280	290,800	277,691	278,056	272,475	261,521	268,752	269,889	280,329	286,163
AO w/CUP removed (AF)	310,216	321,131	308,007	292,522	277,691	279,776	274,188	263,237	270,463	271,601	282,041	287,869
AO (AF)	292,869	294,090	305,572									
AO w/CUP removed (AF)	294,572	295,790	307,271									



### Historical Northern California April 1st Peak Snow Water Equivalent

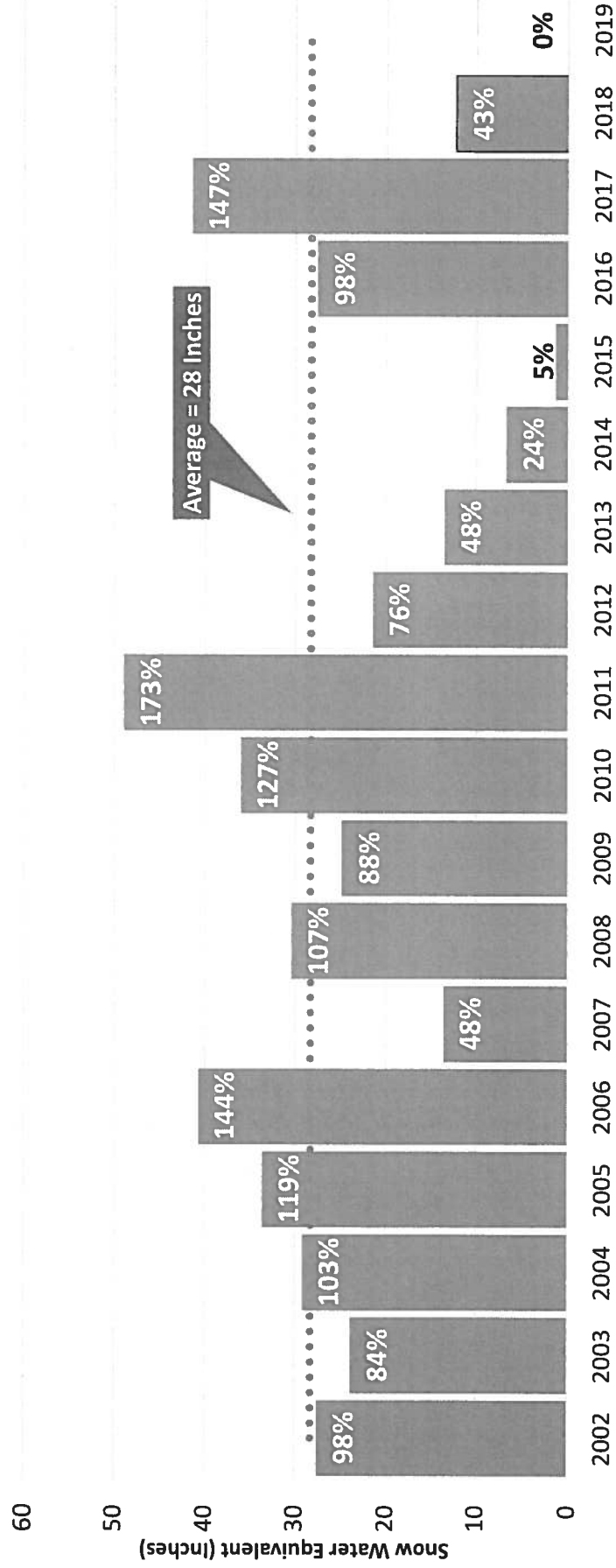

### Historical Colorado Basin April 15th Peak Snow Water Equivalent

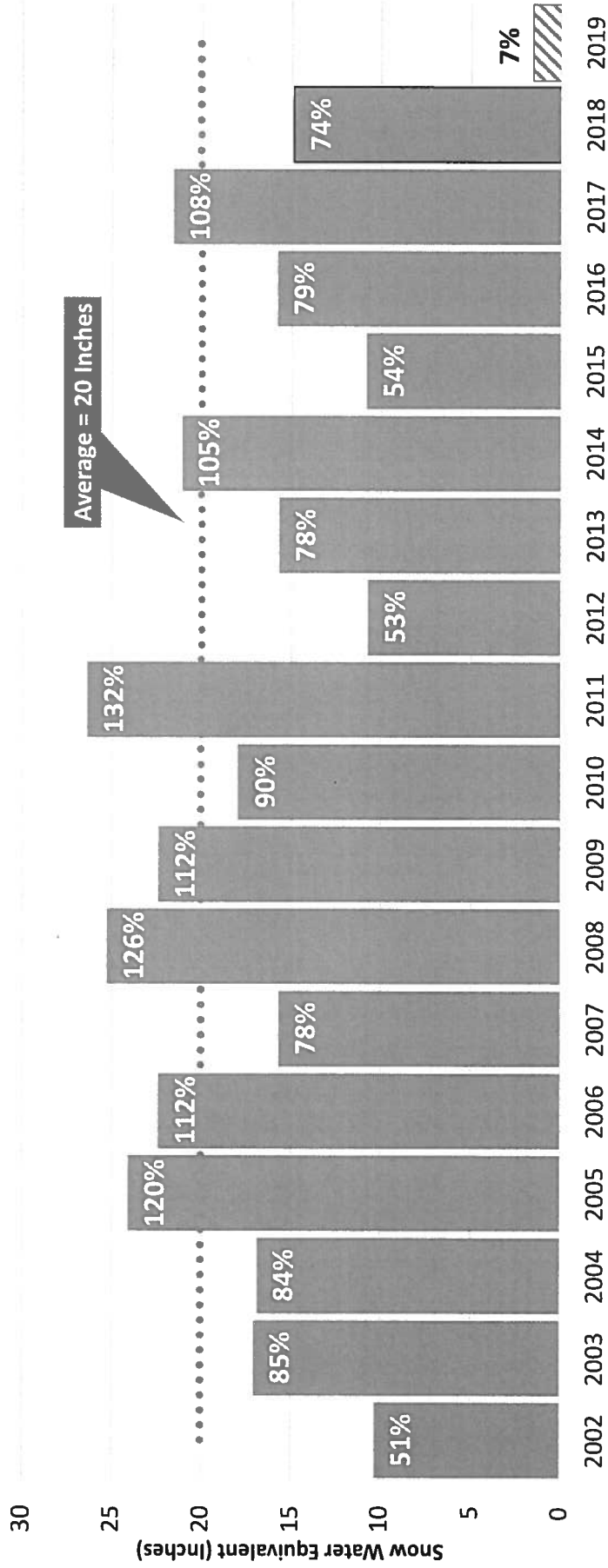



# Lake Mead Levels: Historical and Projected projection per USBR 24-Month Study

Historical  Projected

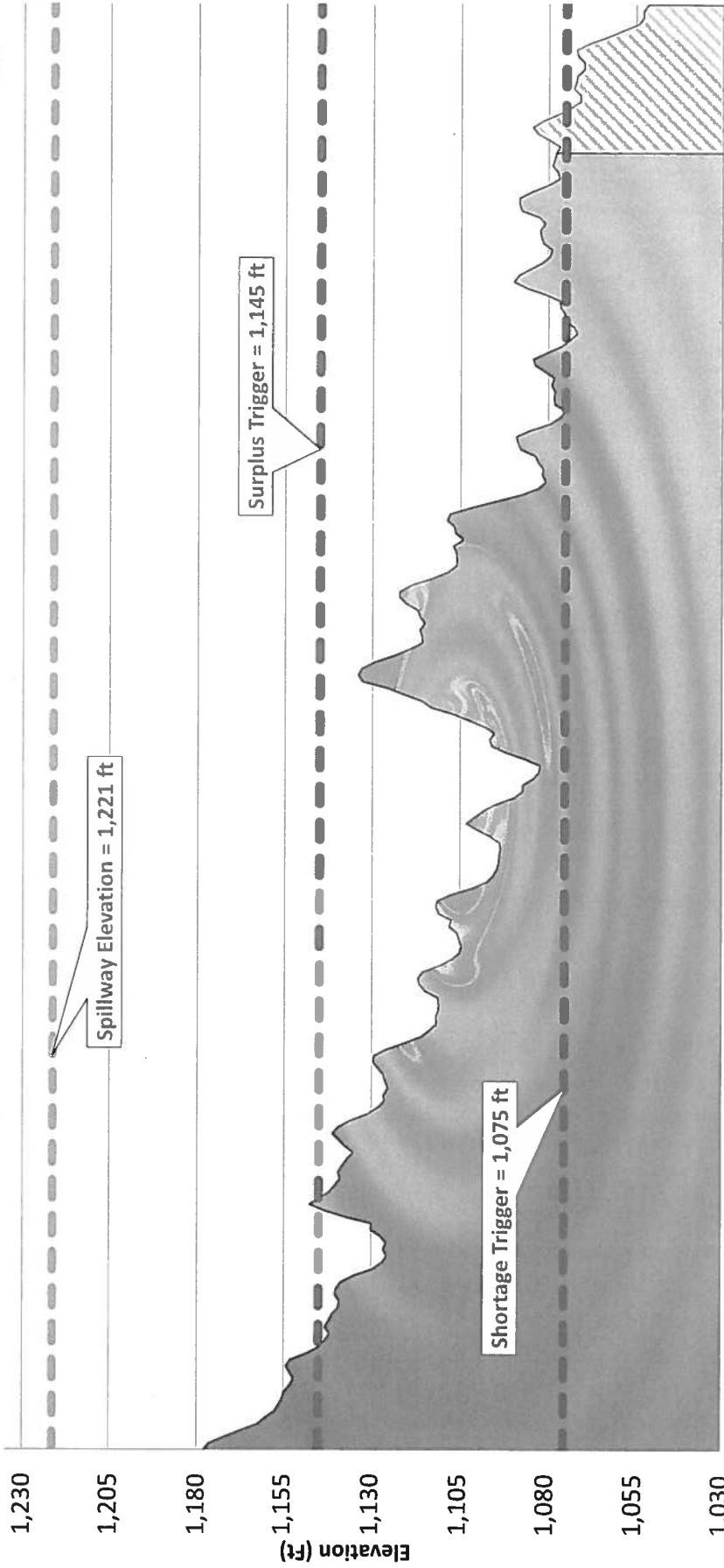

Jan 02 Jan 03 Jan 04 Jan 05 Jan 06 Jan 07 Jan 08 Jan 09 Jan 10 Jan 11 Jan 12 Jan 13 Jan 14 Jan 15 Jan 16 Jan 17 Jan 18 Jan 19 Jan 20



# Lake Powell Levels: Historical and Projected projection per USBR 24-Month Study

Historical  Projected

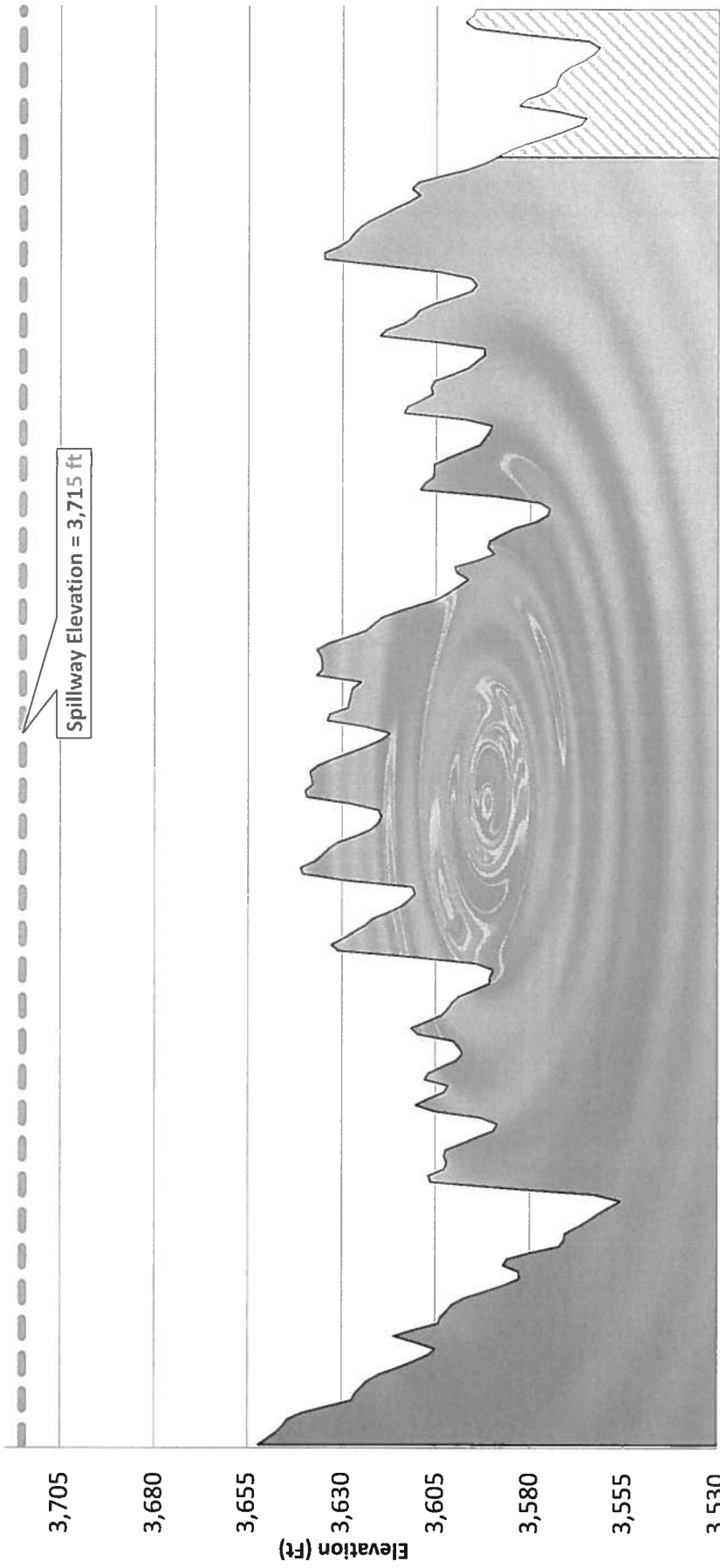

Jan 02 Jan 03 Jan 04 Jan 05 Jan 06 Jan 07 Jan 08 Jan 09 Jan 10 Jan 11 Jan 12 Jan 13 Jan 14 Jan 15 Jan 16 Jan 17 Jan 18 Jan 19 Jan 20



# Lake Mead Historical Water Elevation Level

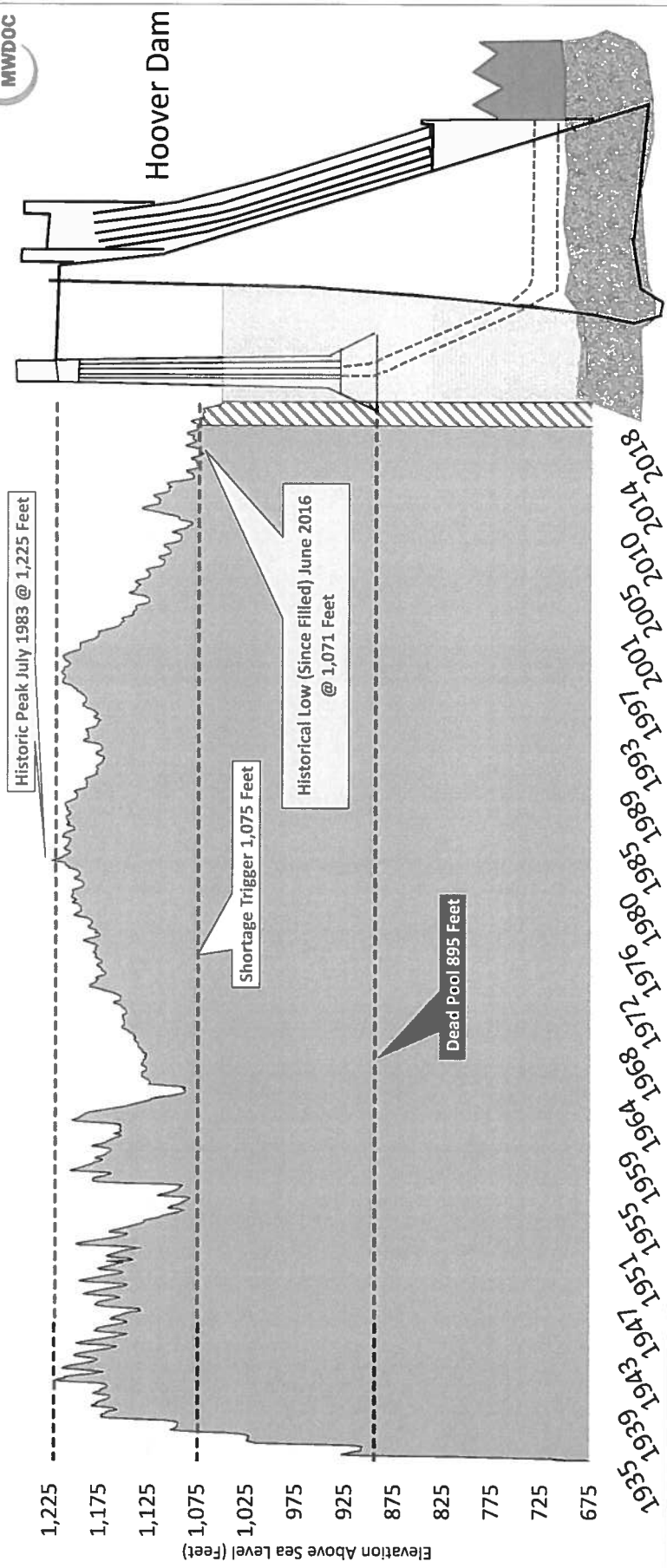

Hoover Dam

Intake Tower

Historic Peak July 1983 @ 1,225 Feet

Shortage Trigger 1,075 Feet

Historical Low (Since Filled) June 2016 @ 1,071 Feet

Dead Pool 895 Feet

Elevation Above Sea Level (Feet)

**WEEKLY MEMO 11-29-18**

**SOCIAL MEDIA  
HIGHLIGHTS**



# Facebook

Nov 22, 2018 - Nov 28, 2018

The Facebook Sent Messages report showcases your social posts across your Facebook pages, and provides performance metrics using a blend of Facebook Insights and proprietary metrics of our own.



**Included in this report are posts for the week of  
November 22, 2018 - November 28, 2018.**



Garden Grove City Hall



Garden Grove Police Department



Garden Grove Fire Department

---

**Total Analytics for November 22, 2018 - November 28, 2018**

Organic Impressions	56,576
Total Reach (per post)	2,207
Reactions	1,135
Comments	170
Users Engaged (per post)	253
Engagement % (per post)	11.47%

Date Sent	Total Reach	Reactions	Comments	Engagement	Clicks
-----------	-------------	-----------	----------	------------	--------



**Garden Grove Fire Department**

**ADULT MALE FALLS FROM THE 22  
FREEWAY ONTO STREET BELOW**

7.9k	255	43	31%	2.7k
------	-----	----	-----	------

Fire fighter paramedics responded to Beach Boulevard at the 22 Freeway shortly before 4:00 p.m. for an adult male that was found on the ground after falling over 20 feet from the freeway overpass. The male was found hanging on the side by a California Highway Patrol officer. The officer blocked traffic lanes, and shortly after the male let go and fell. The male was treated by fire department paramedics for moderate injuries, and transported to a trauma center in stable condition. No motorists were involved or injured.

###



(Post) November 27, 2018 4:50 pm

Date Sent	Total Reach	Reactions	Comments	Engagement	Clicks
-----------	-------------	-----------	----------	------------	--------



**Garden Grove Police Department**

In response to the nationwide increase of fatal accidents involving distracted drivers, bicyclists and pedestrians, the **#GardenGrovePD** **#AccidentReductionTeam** (ART) was created as part of a City campaign to reduce traffic collisions.

3.4k	191	33	15%	598
------	-----	----	-----	-----

To help prevent life-changing injuries and fatalities, ART works with the Office of Community Relations to educate the community on the dangers of being distracted and/or not following traffic laws.

Through **#enforcement** and **#outreach**, the City saw a 40% decrease in the number of fatal accidents.  
 2016 - 17 fatalities  
 2017 - 10 fatalities  
 2018 - 9 fatalities

Recently, ART was recognized by the **#GardenGrove** City Council with a Community Spotlight, for their outstanding work.  
**#GGPD32 #SafeStreetsGG**  
**#StayAlertGG #policework**  
**#thinblueline**  
**Garden Grove City Hall Garden Grove PA**



(Post) November 28, 2018 3:00 pm

Date Sent Total Reach Reactions Comments Engagement Clicks



**Garden Grove Police Department**

On this day of **#gratitude**, we would like to thank the residents and businesses of **#GardenGrove** for their continued support, especially in these trying times. We are honored you've entrusted us to serve you, and we look forward to the continued partnership.

2.7k 141 10 11% 297

We are also **#grateful** for the men and women in **#publicsafety**, and all those in **#publicservice**, who work tirelessly to address the quality of life issues in our neighborhoods.

In observance of the Holiday, our administrative office will be closed today. Have a safe and happy **#Thanksgiving**, from our family to yours.  
**#GGPD32 #thinblueline #doigintermediate**  
**Garden Grove City Hall Garden Grove Fire Department Garden Grove PA**



(Post) November 22, 2018 9:01 am

Date Sent Total Reach Reactions Comments Engagement Clicks



**Garden Grove City Hall**

T-5 days until Winter in the Grove!

3.9k 108 32 8% 296

We hope you are getting ready to experience holiday sights, sounds, and activities at this year's Winter in the Grove, where Winterfest and Christmas Tree Lighting come together into one event.

Enjoy free seasonal refreshments, children's activities, a visit by Santa and Mrs. Claus, and an unforgettable tree lighting ceremony. Unlimited snow rides are \$5, and can be purchased online at [ggcity.org/register](http://ggcity.org/register) or at the event. Food will be available for purchase.

Click the link below for more information.

**#WinterInTheGrove #GG1956  
#GardenGrove Garden Grove Police  
Department Garden Grove Fire  
DepartmentGarden Grove Public Works  
Department Garden Grove Unified  
School District**

**Celebrate the Holidays with "Winter in the Grove" Event December 1 | City of Garden Grove**

(Post) November 26, 2018 4:16 pm



**Garden Grove Police Department**

It's the time of the year to reflect and count our blessings.

2.8k 100 12 9% 220

We are thankful for...the civilians who do the million little things that fall under the words "support staff"; from taking paper (to free up officers for calls), to helping new parents with car seats, to making sure our training arrangements are in order, to ensuring our equipment is working properly, to even unclogging the occasion toilets. Thank you for all the big and small things you do to keep **#GardenGrovePD** running smoothly. **#GGPD32 #GardenGrove #station32 #police #thinblueline #policework #gratitude**



(Post) November 23, 2018 1:30 pm

Date Sent Total Reach Reactions Comments Engagement Clicks



**Garden Grove Police Department**

Join us as Winterfest & The Christmas Tree Lighting come together as one event, this Saturday (12/1) from 4:00 PM - 8:00 PM, at Village Green Park (12732 Main St). Enjoy some holiday sights, sounds & fun activities at our "Winter in the Grove". [bit.ly/2PZFnb](http://bit.ly/2PZFnb)  
**#GGPD32 #GG1956 #GardenGrove Garden Grove City Hall**

3.3k 75 17 5% 160



(Post) November 28, 2018 9:00 am



**Garden Grove City Hall**

In response to the nationwide increase of fatal accidents involving distracted drivers, bicyclists and pedestrians, the **Garden Grove Police Department's #AccidentReductionTeam (ART)** was created as part of a City campaign to reduce traffic collisions.

920 52 3 10% 88

To help prevent life-changing injuries and fatalities, ART works with the Office of Community Relations to educate the community on the dangers of being distracted and/or not following traffic laws.

Through enforcement and outreach, the City saw a 40% decrease in the number of fatal accidents.

- 2016 - 17 fatalities
- 2017 - 10 fatalities
- 2018 - 9 fatalities

Recently, ART was recognized by the Garden Grove City Council with a Community Spotlight for their outstanding work.

**#GG1956 #GardenGrove #SafeStreetsGG #StayAlertGG**



(Post) November 28, 2018 3:14 pm

Date Sent	Total Reach	Reactions	Comments	Engagement	Clicks
-----------	-------------	-----------	----------	------------	--------



**Garden Grove Police Department**

Spread the word and help us reach our goal of 1000 lbs of dry #pasta & canned/jarred pasta sauce, and \$1000.00! Last year, #GardenGrovePD participated in Caterina's Club pasta drive; staff donated over 350 pounds of pasta and sauce, as well as over \$500 in cash.

2.5k	40	4	4%	92
------	----	---	----	----

Caterina's Club cooks 17,000 meals a week for homeless "motel kids" in Orange County, as well as help transition motel families into permanent housing, and provides job training for at-risk teenagers. The foundation was started by #ChefBruno Serato of #AnaheimWhiteHouseRestaurant, and has a #PastaThon fundraiser every December.

Public donations are being accepted at our front lobby, during normal business hours until December 7th. For monetary donations, you can also go directly to their website at <http://caterinasclub.org/>. We will be presenting our donations on-air with The Official KFI AM 640, at Christ Cathedral that morning.

#GGPD32 #station32 #community #thethinblueline #GivingTuesday  
 Garden Grove City Hall Garden Grove PA



(Post) November 27, 2018 12:00 pm

Date Sent	Total Reach	Reactions	Comments	Engagement	Clicks
-----------	-------------	-----------	----------	------------	--------



**Garden Grove Fire Department**

The **#SparkofLove** toy drive is up & running!

1.2k

38

-

4%

14

Join us & Southern California firefighters in partnering with **ABC7** to collect toys/sport equipment for kids that would otherwise go without. You can bring an unwrapped new toy/equipment to any 🏠. Thank you 🙏.



(Post) November 25, 2018 11:43 am



Date Sent	Total Reach	Reactions	Comments	Engagement	Clicks
-----------	-------------	-----------	----------	------------	--------

**Garden Grove Police Department**

Before you go online and take advantage of the **#CyberMonday** deals, here are a few reminders...

2.7k

27

3

4%

91

1. Install Security Patches. Stay protected from cyberattacks by installing the latest security patches and updates.

2. Shop On Secure Sites. Watch out for look-alike URLs that use the names of well-known brands. A secure website will have https:// in the URL. The "s" is what lets you know the site is secure. Secure sites also have a small lock icon in the lower right corner of the screen.

3. Avoid Public Wi-Fi/Hotspots. Public networks can make you vulnerable to hackers, who could steal valuable data and cause other damages to you.

4. Say No to Clicking Links. Shop with brands you know and trust. Be wary of deals that seem too-good-to-be-true.

5. Use Credit vs Other Options. Credit cards offer protection from identity theft that debit cards don't.

6. Check Statements Regularly. Don't wait for your bill to come at the end of the month. Go online regularly to review your account activities. Look for any fraudulent charges.

7. No To Porch Pirates. Packages left unattended are easy targets for thieves. Sign up for delivery alerts; have packages delivered to local branches of stores and pick them up in-store; or get packages delivered to your office, if you can't be home at the time of delivery.

Take the time to shop securely and take precautions so your packages aren't gifts for **#porchpirates**. A stolen identity or stolen packages can put a "bah humbug" in your holidays.

**#GGPD32 #CrimePrevention**

**#shopsmart**

**#StayAlertGG**

**Garden Grove City Hall Garden Grove  
Fire Department Garden Grove PA**

(Post) November 26, 2018 6:30 am

Date Sent Total Reach Reactions Comments Engagement Clicks



**Garden Grove City Hall**

We wish everyone a safe and happy  
**#Thanksgiving** from the City!

1.2k 24 3 3% 14

Thank you for letting us serve you  
**#GardenGrove**.

**#GG1956**



(Post) November 22, 2018 1:32 pm



**Garden Grove Fire Department**

The National Weather Service is  
expecting **#rain** as early as tonight with  
the heaviest tomorrow. If you need sand  
& bags, they're available to Garden  
Grove residents at fire stations 2, 3, & 4.  
Their location can be found on our  
website at [gardengrovefire.org](http://gardengrovefire.org). **#cawx**

1.3k 21 1 8% 99



(Post) November 28, 2018 2:13 pm

Date Sent Total Reach Reactions Comments Engagement Clicks



**Garden Grove City Hall**

The City's annual Black Friday Goes BiGG campaign begins today! For every \$50 in total register receipts from any Garden Grove business, including restaurants, gas stations, and grocery stores, you'll receive one raffle ticket towards \$500 cash or a one-night stay at the **Great Wolf Lodge** Southern California. Happy shopping!

1.6k 16 3 4% 63

**\*\*Raffle tickets will not be available at establishments. Receipts must be brought to the Garden Grove Chamber of Commerce, at 12866 Main Street, Suite 102, by 5:00 p.m., Friday, December 14, 2018. There is no limit on the number of raffle tickets received. For more information, visit <https://ggcity.org/news-and-events/shop-local-win-500-and-more>. #gg1956 #shoplocal #blackfriday Think #BiGG - Buy in #GardenGrove**



(Post) November 23, 2018 6:00 am

Date Sent	Total Reach	Reactions	Comments	Engagement	Clicks
-----------	-------------	-----------	----------	------------	--------



**Garden Grove City Hall**

Today is **#SmallBusinessSaturday** and we're encouraging the community to support local, small businesses! See the impact you can make when you **#shopsmall**.

1.2k	12	-	3%	30
------	----	---	----	----

Remember to save your receipts for the City's end-of-year shop local campaign, Black Friday Goes BIGG. From now until Friday, December 14, Garden Grove shoppers have the opportunity to win \$500 cash or a one-night stay at the **Great Wolf Lodge** Southern California. Learn how at <https://ggcity.org/news-and-events/shop-local-win-500-and-more>.

Think **#BiGG** - Buy in **#GardenGrove**  
**#GG1956** Garden Grove Chamber of Commerce Mr Matcha Small Business Saturday



(Post) November 24, 2018 8:00 am

Date Sent Total Reach Reactions Comments Engagement Clicks



**Garden Grove City Hall**

The community is invited to the grand opening of **Pearson Fuels** 100th Flex Fuel E85 retail station, on Thursday, November 29, from 10:00 a.m. to 3:00 p.m., at **Chevron**. In celebration of the milestone achievement, Pearson Fuels is offering Flex Fuel E85 for 85 cents per gallon during the grand opening event.

1.9k 10 4 7% 152

To learn more about Flex Fuel E85, visit <https://pearsonfuels.com/home/>.  
**#PearsonFuels #E85 #FlexFuel #AlternativeFuel**

**#GG1956 #GardenGrove Garden Grove Chamber of Commerce**



(Post) November 25, 2018 12:00 pm



**Garden Grove City Hall**

**HEAVY RAIN FORECAST - ORANGE COUNTY FLASH FLOOD WATCH**

849 7 - 6% 44

The National Weather Service has released a Flash Flood Warning for the Santa Ana Mountains, Foothills, and Orange County areas - Garden Grove is included in the weather watch advisory. -  
 -> <https://patch.com/california/trabuco-canyon/orange-county-flash-flood-watch-holy-canyon-fire-burn-scar-area>.

Sand and bags are available to Garden Grove residents at the following fire stations:

- Station 2: 11805 Gilbert St.
  - Station 3: 12132 Trask Ave.
  - Station 4: 12191 Valley View St.
- Garden Grove Fire Department**

**#gg1956 #gardengrove #flashfloodwarning #rain #staysafegg**



(Post) November 28, 2018 5:10 pm

Date Sent	Total Reach	Reactions	Comments	Engagement	Clicks
-----------	-------------	-----------	----------	------------	--------



### Garden Grove City Hall

The community is invited to attend **OC Drive's** 3rd annual Winter Toy Drive this Sunday, December 2, from 11:00 a.m. to 3:00 p.m., on Historic Main Street in downtown **#GardenGrove**. Event festivities include making gingerbread houses, holiday cards, music, an exotic car show, raffle prizes, and a visit from Santa. Several local eateries will be handing out food and refreshment samples, including **7 Leaves Cafe** and **Saigon City Marketplace**.

811

8

2

2%

17

The cost per attendee is a new, unwrapped toy valued at \$10 or more. All toy donations are given to local youth in the community.

For full details, please visit OC Drive's Facebook Event Page at <https://www.facebook.com/events/279334552702879/>.

\*Due to the Winter Toy Drive event, the Farmer's Market will not take place that day.

**#gg1956 #ocdrive #wintertoydrive #communityevent**



(Post) November 28, 2018 9:24 am

Date Sent Total Reach Reactions Comments Engagement Clicks



**Garden Grove City Hall**

This **#GivingTuesday**, help spread holiday cheer to local children and families that are underprivileged. Donate unused toys, board games, canned food, and more to the Buena Clinton Youth and Family Center and Magnolia Park Family Resource Center's 2018 Garden Grove Holiday Drive. Learn how you can give, visit <https://ggcity.org/news-and-events/bring-joy-local-families-donate-garden-groves-holiday-drive>.

921 6 - 3% 30

**#gg1956 #gardengrove #community #holidaytoydrive #giveback #familyresourcecenters**



(Post) November 27, 2018 9:37 am



**Garden Grove City Hall**

**\*Bolsa Chica Road bridge closure tonight\***

819 4 - 3% 28

Bolsa Chica Road bridge will be closed from 10:00 p.m. Tuesday, November 27 to 5:00 a.m. Wednesday, November 28. Crews will restripe lanes and adjust k-rail.

Please visit [octa.net/405map](http://octa.net/405map) for detour routes.

**#405improvement**



(Post) November 27, 2018 3:52 pm



Twitter

for **@CityGardenGrove**

Nov 22, 2018 - Nov 28, 2018

The Twitter Sent Messages report showcases your tweets across your Twitter profiles, and provides performance metrics using a variety of engagement metrics.



Included in this report are tweets for the week of  
November 22, 2018 - November 28, 2018.



@CityGardenGrove

---

**Total Analytics for November 22, 2018 - November 28, 2018**

Potential Reach	44,845
Responses	1
All Clicks	39

Date Sent Potential Reach Organic Impressions Responses Likes Clicks



CityGardenGrove

HEAVY RAIN FORECAST - ORANGE COUNTY FLASH FLOOD WATCH - [bit.ly/2DQ3ssD](https://bit.ly/2DQ3ssD) - Sand and bags are available to Garden Grove residents at the following fire stations:  
 Station 2: 11805 Gilbert St  
 Station 3: 12132 Trask Ave  
 Station 4: 12191 Valley View St  
 @GardenGroveFire #gg1956  
[pic.twitter.com/27p32kaBZ4](https://pic.twitter.com/27p32kaBZ4)

2.9k 407 1 2 6



(Tweet) November 28, 2018 5:11 pm





CityGardenGrove

@GardenGrovePD's #AccidentReductionTeam (ART) was recognized by the #GardenGrove City Council with a Community Spotlight for their outstanding police work. 📸 More info. at [bit.ly/2PcuoVG](https://bit.ly/2PcuoVG) #GG1956 #SafeStreetsGG #StayAlertGG  
[pic.twitter.com/TeX8i3OPoJ](https://pic.twitter.com/TeX8i3OPoJ)

40 161 1 5 4



(Tweet) November 28, 2018 3:20 pm

Date Sent	Potential Reach	Organic Impressions	Responses	Likes	Clicks
	<p><b>CityGardenGrove</b></p>	2.9k	233	-	-
<p>The community is invited to attend @oc_drive's 3rd annual Winter Toy Drive this Sunday, December 2, from 11:00 a.m. to 3:00 p.m., on Historic Main Street in downtown #GardenGrove. For full details, please visit OC Drive's Facebook Event Page at <a href="https://facebook.com/events/2793345...">facebook.com/events/2793345...</a> #gg1956</p>					
<p>(Retweet with Comment) November 28, 2018 9:28 am</p>					
	<p><b>CityGardenGrove</b></p>	2.9k	233	2	1
<p>Bolsa Chica Road bridge will be closed from 10:00 p.m. Tuesday, November 27 to 5:00 a.m. Wednesday, November 28. Crews will restripe lanes and adjust k-rail.</p>					
<p>Please visit <a href="https://octa.net/405map">octa.net/405map</a> for detour routes.</p>					
<p>#405improvement #GG1956 @405improvement <a href="https://pic.twitter.com/PPKFI2HP4b">pic.twitter.com/PPKFI2HP4b</a></p>					
					
<p>(Tweet) November 27, 2018 3:51 pm</p>					

Date Sent Potential Reach Organic Impressions Responses Likes Clicks



**CityGardenGrove**

This **#GivingTuesday**, help spread holiday cheer to local children & families that are underprivileged. Donate toys, board games, canned food & more to the Buena Clinton Youth & Family Center and Magnolia Park Family Resource Center. Learn how, visit [bit.ly/2P5kAN9](http://bit.ly/2P5kAN9) **#gg1956** [pic.twitter.com/J0TkkKzbJZ](http://pic.twitter.com/J0TkkKzbJZ)

2.9k 788 1 1 2



**#GIVINGTUESDAY**

NOV 27



(Tweet) November 27, 2018 9:58 am



**CityGardenGrove**

T-5 days until Winter in the Grove! Get ready to experience holiday sights,sounds,&activities at this year's Winter in the Grove, where Winterfest&Christmas Tree Lighting come together into one event on 12/1 4PM-8PM @ Village Green Park [bit.ly/2PZF nab](http://bit.ly/2PZF nab) **#GG1956** [pic.twitter.com/jj12BUBspq](http://pic.twitter.com/jj12BUBspq)

4.2k 763 1 3 20



(Tweet) November 26, 2018 4:20 pm

Date Sent Potential Reach Organic Impressions Responses Likes Clicks



CityGardenGrove

The community is invited to the grand opening of Pearson Fuels 100th Flex Fuel E85 retail station, on Thursday, November 29, from 10:00 a.m. to 3:00 p.m., at Chevron.

17.1k 844 4 6 -

To learn more about Flex Fuel E85, visit [pearsonfuels.com/home/](http://pearsonfuels.com/home/).

#GG1956 pic.twitter.com/9mgBBGitgO

PEARSONFUELS  
FEEL GOOD. FUELING UP.

**JOIN US IN CELEBRATING  
THE OPENING OF OUR  
100<sup>th</sup> FLEX FUEL STATION!**

Chevron  
11971 Valley View St.  
Garden Grove, CA 92845

**FLEX FUEL E85 FOR 85¢/GALLON  
THURSDAY, NOVEMBER 29<sup>TH</sup>**

From 10 am to 3 pm!

**E85**  
85% Ethanol

**FLEX FUEL**  
E85 FUEL

9

For More Information Visit  
**PearsonFuels.com or Download our App!**

Follow Us On: /PearsonFuels /PearsonFuels @PearsonFuels

FOR FLEX FUEL STATIONS ONLY. NO EXCHANGE. SEE ANY BIKES ARE TO BE HATED. NO DRAGGING. NO SLIPPERIES. LAST.

(Tweet) November 25, 2018 12:00 pm

Date Sent Potential Reach Organic Impressions Responses Likes Clicks



CityGardenGrove

Today is **#SmallBusinessSaturday** & we're encouraging the community to support local,small businesses!

2.9k 283 - - 1

Remember to save your receipts for the City's end-of-year shop local campaign, Black Friday Goes BiGG.  
[bit.ly/2TxWgXC](https://bit.ly/2TxWgXC) **#GG1956**  
[pic.twitter.com/3pHp75SMlg](https://pic.twitter.com/3pHp75SMlg)



(Tweet) November 24, 2018 8:00 am



CityGardenGrove

The City's annual Black Friday Goes BiGG campaign begins today!

4.2k 598 3 1 6

For every \$50 in total register receipts from any **#GG** business you'll receive 1 raffle ticket towards \$500 cash or a 1-night stay at GWL.

For more info, visit [bit.ly/2FD6wL9](https://bit.ly/2FD6wL9)  
**#GG1956 #BiGG**  
[pic.twitter.com/Kv8OCWj9uw](https://pic.twitter.com/Kv8OCWj9uw)



(Tweet) November 23, 2018 6:00 am

Date Sent	Potential Reach	Organic Impressions	Responses	Likes	Clicks
-----------	-----------------	---------------------	-----------	-------	--------



**CityGardenGrove**

We wish everyone a safe and happy  
**#Thanksgiving** from the City!

4.8k

546

1

1

-

Thank you for letting us serve you  
**#GardenGrove**.

**#GG1956** [pic.twitter.com/ph2QMaPFLQ](https://pic.twitter.com/ph2QMaPFLQ)

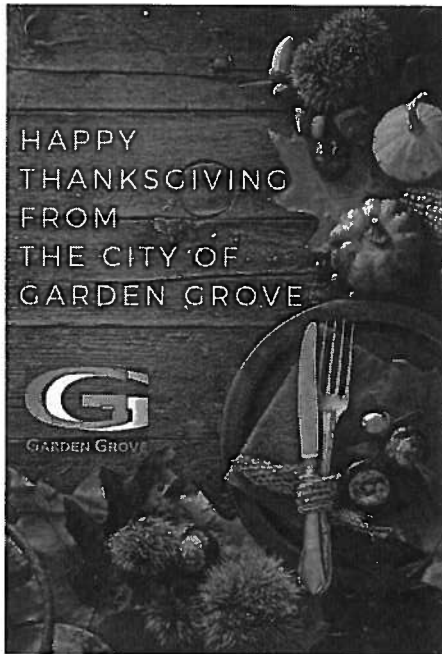

(Tweet) November 22, 2018 1:34 pm

**WEEKLY MEMO 11-29-18**

# **NEWS ARTICLES**



# Where is homebuying slowing more: In Garden Grove, Huntington Beach, Fountain Valley or Westminster?

By Jonathan Lansner  
jlansner@scng.com  
@jonlan on Twitter

Homebuying in what we'll call the "Beach Boulevard Corridor" — in and around Huntington Beach, Fountain Valley, Garden Grove and Westminster — fell 4 percent this summer vs. a year ago.

It was the slowest-selling third quarter in four years for Orange County's housing market as buyers balked at high prices and expensive mortgages and homeowners and builders boosted the supply of residences for sale.

Here's what my trusty spreadsheet told me when I looked at house-hunting patterns at the neighbor-

hood level in 2018's summer quarter vs. the July-to-September period a year earlier.

CoreLogic found these 19 trends in 13 ZIP codes covered by The Orange County Register's The Wave weekly newspaper ...

**1. PURCHASES** » Home sales in this period totaled 1,157, vs. 1,201 a year ago, a decline of 3.7 percent.

**2. WHO'S UP** » Prices increased in 10 of the 13 ZIPs as sales rose in four ZIPs.

**3. COUNTYWIDE** » \$734,000 median selling price, up 3.4 percent. Orange County sales totaled 9,160 residences — existing and new — vs. 10,350 a year ago, a decline of 11.5 percent.

Prices rose in 50 out of 83 Orange County ZIPs, and

sales were up in 21 out of 83 ZIPs.

Here is how prices and sales moved at the community level:

**4. FOUNTAIN VALLEY 92708** » \$777,500 median, up 5.6 percent. Price rank? 32nd of 83. Sales of 146, vs. 143 a year ago, a gain of 2.1 percent.

**5. GARDEN GROVE 92840** » \$568,000 median, up 11.4 percent. Price rank? No. 70 of 83. Sales of 120, vs. 118 a year ago, a gain of 1.7 percent.

**6. GARDEN GROVE 92841** » \$650,000 median, up 15.7 percent. Price rank? No. 55 of 83. Sales of 43, vs. 50 a year ago, a decline of 14 percent.

**7. GARDEN GROVE 92843** » \$585,000 median, up 7.5

percent. Price rank? No. 65 of 83. Sales of 43, same as a year ago.

**8. GARDEN GROVE 92844** » \$485,000 median, up 14.1 percent. Price rank? No. 80 of 83. Sales of 39, vs. 44 a year ago, a decline of 11.4 percent.

**9. GARDEN GROVE 92845** » \$670,000 median, up 1.9 percent. Price rank? No. 51 of 83. Sales of 50, same as a year ago.

**10. HUNTINGTON BEACH 92646** » \$677,000 median, down 7.5 percent. Price rank? No. 50 of 83. Sales of 182, same as a year ago.

**11. HUNTINGTON BEACH 92647** » \$742,500 median, down 3.6 percent. Price rank? No. 37 of 83. Sales of 104, vs. 100 a year ago, a gain of 4 percent.

**12. HUNTINGTON BEACH 92648** » \$980,000 median, up 13.3 percent. Price rank? No. 14 of 83. Sales of 129, same as a year ago.

**13. HUNTINGTON BEACH 92649** » \$844,250 median, up 13 percent. Price rank? No. 26 of 83. Sales of 115, vs. 126 a year ago, a decline of 8.7 percent.

**14. MIDWAY CITY 92655** » \$650,000 median, down 13.3 percent. Price rank? No. 55 of 83. Sales of 11, vs. nine a year ago, a gain of 22.2 percent.

**15. STANTON 90680** » \$439,000 median, up 2.8 percent. Price rank? No. 81 of 83. Sales of 45, vs. 77 a year ago, a decline of 41.6 percent.

**16. WESTMINSTER 92683** » \$665,000 median, up 9.4

percent. Price rank? No. 54 of 83. Sales of 130, same as a year ago.

Plus three more county-wide trends found this summer vs. a year ago:

**17. SINGLE-FAMILY-HOME RESALES** » 5,618 Orange County sales, vs. 6,284 a year ago, a decline of 10.6 percent in the period. Median: \$785,500 — a rise of 3.4 percent in the period.

**18. CONDO RESALES** » 2,429 sales, vs. 2,802 a year ago, a dip of 13.3 percent. Median: \$513,000 — a rise of 4.7 percent in a year.

**19. NEW HOMES** » Builders sold 1,113 residences, vs. 1,263 a year ago, a decline of 11.9 percent in 12 months. Median: \$985,000 — a rise of 11.6 percent in a year.

et g for a way to cel-  
H e holiday season?  
tr ampling of things  
und the county:

## GARDEN GROVE

**Community celebra-  
tion:** The city is combining  
Winterfest and the com-  
munity tree lighting into  
one celebration: Winter in  
the Grove. There will be  
children's activities, a snow  
slide, a visit by Santa Claus  
and Mrs. Claus and the  
lighting of the tree from 4 to  
8 p.m. Dec. 1 at Village Green  
Park, 12732 Main St. Free  
admission, snow slide is \$5.  
ggcity.org

**On stage:** The Gem The-  
ater's "The Holiday Gem"  
will run through Dec. 16  
and is meant for the whole  
family. The holiday review  
features classic songs from  
the season, tap-dancing  
elves backing up Santa  
Claus and scenery that will  
transport you to Victorian  
England for a snowy Christ-  
mas. Live musicians provide  
the soundtrack. Shows are  
Thursday-Sunday at various  
hours. Tickets are \$30 gen-  
eral admission, \$26 children  
and seniors. onemorepro-  
ductions.com

**Holiday concert:** The  
Christ Cathedral Choirs will  
perform a holiday concert  
Dec. 14. Under the direc-  
tion of John Romeri, they  
will offer classic carols and  
Vivaldi's "Gloria" during the  
7:30 p.m. concert that is  
open to the community in  
the Christ Cathedral Arbo-  
retum. General admission is  
\$25. christcathedralmusic.  
org

The Wave  
November 29, 2018

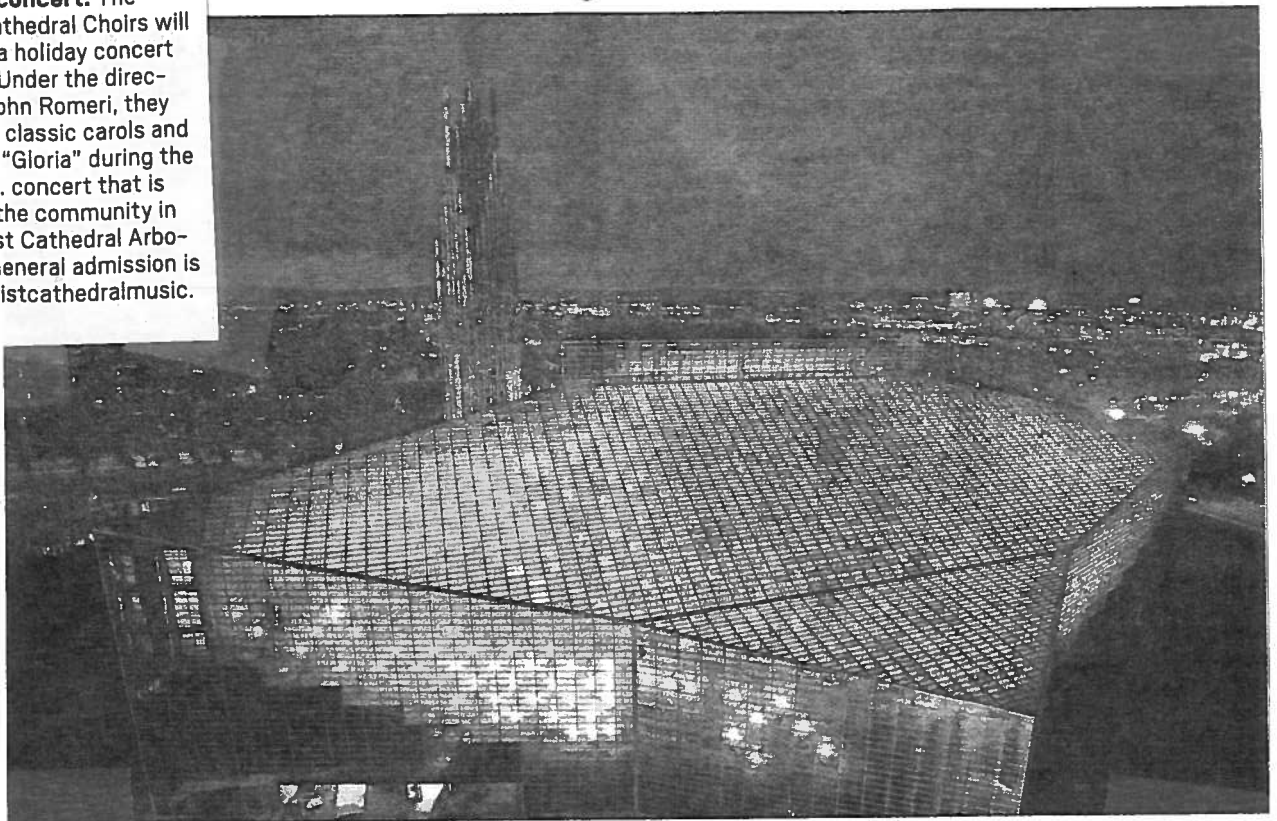

FILE PHOTOS

Christ Cathedral will host a holiday concert by the Christ Cathedral Choirs on Dec. 14. They will perform classic carols and Vivaldi's "Gloria."

The Wave  
November 22, 2018



THE GEM THEATER

The "Holiday Gem" will offer familiar songs and images, dancing and live music.

## 'Holiday Gem' to open at the Garden Grove Gem Theater

The Gem Theater opens its annual holiday show Friday.

"The Holiday Gem" will run through Dec. 16 and is meant for the whole family.

The revue features classic songs from the season, tap dancing elves backing up Santa Claus and

scenery that will transport you to Victorian England for a snowy Christmas. Musicians provide the soundtrack.

The show is described as both lighthearted and genuinely moving.

— Heather McCrea

### IF YOU GO

**When:** Friday through Dec. 16; various hours Thursday-Sunday

**Where:** Gem Theater, 12852 Main St., Garden Grove

**Cost:** \$30 general, \$25 children and seniors

**Information and box office:**  
onemoreproductions.com



Photos by Lisa Scarsi

Cast members from "Holiday Gem" have fun with a scene in the Christmas-themed play. Holiday Gem plays at Garden Grove's Gem Theatre through Dec. 16.

## 'O Holy Night' at the Gem

Holiday season kicks off with heart-warming Christmas play

**By Angela Hatcher**

The Gem Theatre has done it again, only this time it's bigger, better, and more spectacular than Santa himself could have imagined.

It's One More Productions' 7th annual "Holiday Gem" extravaganza, and it is one of the most dazzling and heartwarming Christmas musicals this side of the North Pole.

With Set Designer Wally Hunt-oon's beautiful, snow-capped trees and some of Orange County's finest musicians (under the direction of Damien Lorton) setting the mood, The Holiday Gem takes its audience on a nonstop ride to Christmas Fantasy Land where even the most irritable non-believers discover what is possible "if only you believe."

The adorable, decked-out elves, Ernie (Johnnie Gillies) and Emma (Megan Michell), must find a way to raise holiday cheer, and it could very well take a magical snow globe to do the convincing.

Once the gang has been transported up north (Alice in Wonderland style), the tough assignment of bringing back the magic and celebrating all the special times begins.

This original storybook comes to life in such a beautiful way, but there is so much more to this



The performances in "Holiday Gem" are stunning, and the costumes are described as "vibrant and eye-catching with glitter and chiffon..."

little gem than just the storyline. The musical review is a variety show like no other and the musical numbers are sparkling and alive with some hilarious takes on familiar holiday songs.

As for the dancing, choreographed by Shauna Bradford, Heather Holt-Smith, and Danny Diaz, the high energy precision is at its very best in all the num-

bers but "Dear Mr. Santa" with Tad Fujioka and the Showgirls, Evelyn (Danny Diaz) and the little Elves' "Oogie Boogie Song," "Santa Claus is Coming to Town" featuring Santa (Damien Lorton) and "Be a Santa" with Santa and Full Company are showstoppers that have the audience howling with delight.

Costumes are vibrant and eye-see GEM, page 4

# GEM:

Continued from page 1

catching with glitter and chiffon while in Act II, the cast is stunning in elegant jewel-toned gowns and top hats and tails.

Nicole Cassesso and Damien Lorton's concept of their highly successful Holiday Gem has evolved over the years, and newbies will be dazzled by the over the top delirium, but the familiarity of tradition remains with its lovely arrangements of carols such as "Silver Bells" and "O Holy Night."

The audience also sings along to "Silent Night," "O Come All Ye Faithful," "Joy to the World," and more. Personal holiday memories come flooding back when the trio featuring Nicole Cassesso, Hanna Clair, and Erika Baldwin share their childhood stories during "Have Yourself a Merry Little Christmas."

With so many incredible performances it is difficult to single out individual cast members; however, the outstanding men-

tions are: Adriana Sanchez, the amazingly talented and comedic Mrs. Claus (this show would not be the same without her), Damien Lorton, one of the most energetic and hilarious Santas on the planet, Danny Diaz, the guy you love to hate as the evil Evelyn, Shayna Gayer as the most adorable Elf, along with Johnnie Gillies who takes his role to heart, Megan Mitchell as Evelyn's assistant, Nicole Cassesso who shares her incredible comedic and dramatic talents with ease, also, Erika Baldwin, and Tad Fujioka.

This memory-making Christmas card is to be shared with family and friends, young and old, and since this is the last in the OMP's Holiday Gem series, it is not to be missed.

One More Productions has some very exciting productions coming in its 2019 season, and Disney's "Beauty and the Beast" will be next year's holiday gem.

"Holiday Gem"

Gem Theatre  
12852 Main St., GG  
714-741-9550, ext 221.  
Runs through Dec. 16

OC News  
November 28, 2018  
Page 3 of 3



Photo by Lisa Scarsi

Don't miss the artistry and action at "Holiday Gem," which shows at Garden Grove's Gem Theatre through Dec. 16.

---

## Editor's Take

---

And Christmas music echoes through department stores and, seemingly, everywhere else.

Our cities are planning their tree lightings (Garden Grove's is from 4 to 8 p.m. Dec. 1 at Village Green Park; Stanton's is from 6 to 7:30 p.m. Dec. 6 at Stanton Central Park; Westmin-

see GIFT, page 4

---

## GIFT:

Continued from page 1

ster's is at 6:30 p.m. on Dec. 3 at the Westminster Civic Center).

Tree lots are popping up like giant gardens in full bloom.

Santa is making the rounds, most prominently, perhaps, at the Westminster Mall.

Kids are making their lists and checking them twice. Grown-ups started shopping on Black Friday and Small Business Saturday (the Friday and Saturday

following Thanksgiving day).

It really is the most wonderful time of the year.

Want to make it most wonderful? Most beneficial to everyone? Most lucrative for all?

Shop local.

At the mall, on Historic Main Street in Garden Grove, on Beach Boulevard in Stanton, in Little Saigon, at mom-and-pop stores on Garden Grove Boulevard and Westminster Boulevard.

Support your local economy.

Support your local church, synagogues, mosques and temples.

It's the greatest holiday gesture of all - the gift that keeps on giving, the celebration where everyone wins.

Make your community - Westminster, Stanton, Garden Grove - your extended family.

Happy holidays.

*Brady Rhoades is the editor. He can be reached at [brhoades@localnewspapers.org](mailto:brhoades@localnewspapers.org).*

# Umberg noses by Nguyen in Senate race

About 400 votes separate the two as final ballots are counted

By Brady Rhoades

State Sen. Janet Nguyen, a Republican fixture and near sure-bet in Westminster and Garden Grove for years, is in the race of her life.



Challenger Tom Umberg, a Democrat, was leading by about 400 votes as the final votes were being tallied earlier this week. About 250,000 votes had been counted; it's unclear how many more are left to count.

Nguyen, a Republican whose headquarters are on Main Street in Garden Grove, has held the seat since 2014. She served on the Garden Grove City Council starting in 2004 and as an Or-

see RACE, page 4

ange County Supervisor before moving on to the Senate.

Like thousands of her constituents in the Little Saigon area, Nguyen immigrated from Vietnam after the Fall of Saigon and has been steadfast in her support of veterans and respect for the American flag. She has been criticized for grandstanding and going too far — such as when she criticized former lawmaker Tom Hayden for his “pro-communist” activities while her colleague were planning to commemorate him after his death.

This fall, her campaign sent out a mailer — in Vietnamese — accusing Umberg, an Army veteran and winner of the Bronze Star, of the same thing.

She is considered a moderate Republican who prefers community outreach to the less fortunate and disenfranchised over

government intervention. She holds an annual free healthcare expo for those in need.

Nguyen has served as vice-chair of the Senate's Health



Courtesy photo

**Challenger Tom Umberg**

Committee, vice-chair of the Senate Governance and Finance Committee and member of the Human Services and Veterans Committees.

Umberg, a former Army colonel and Assemblyman, has made healthcare and public safety his No. 1 priorities.

“In the State Senate, I will protect the Affordable Care

Act and fight to expand access to healthcare for everyone in California” he said. “Every Californian should have access to quality, affordable healthcare. In the State Senate I will fight the Trump Administration to expand healthcare, not take coverage away for those who need it most.”

Umberg, who owns and operates his own boutique law firm, has been criticized for being too beholden to special interests. Critics have called him a corporate lobbyist and pointed out he's been elected to public office three times (all for the Assembly), but has lost bids for state Attorney General, Insurance Commissioner, State Senate and Orange County Supervisor.

“Retread” is word critics use when talking about the 63-year-old Umberg (Nguyen is 42).

Umberg was appointed by President Bill Clinton to be the nation's Deputy Drug Czar in 1997. He earned the Bronze Star for his service in Afghanistan.

OC News  
November 28, 2018



THURSDAY, NOVEMBER 29TH, 2018

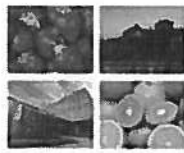

# ORANGE COUNTY TRIBUNE

■ Garden Grove  
■ Huntington Beach  
■ Westminster  
and Orange County

[www.orangecountytribune.com](http://www.orangecountytribune.com) Non-partisan news, opinion, arts and sports. Updated daily.

OPINION

OC Tribune  
November 28, 2018  
1 of 2

## Sources: A charter school for GGUSD?

BY OC TRIBUNE STAFF ON NOVEMBER 28, 2018 • ( LEAVE A COMMENT )

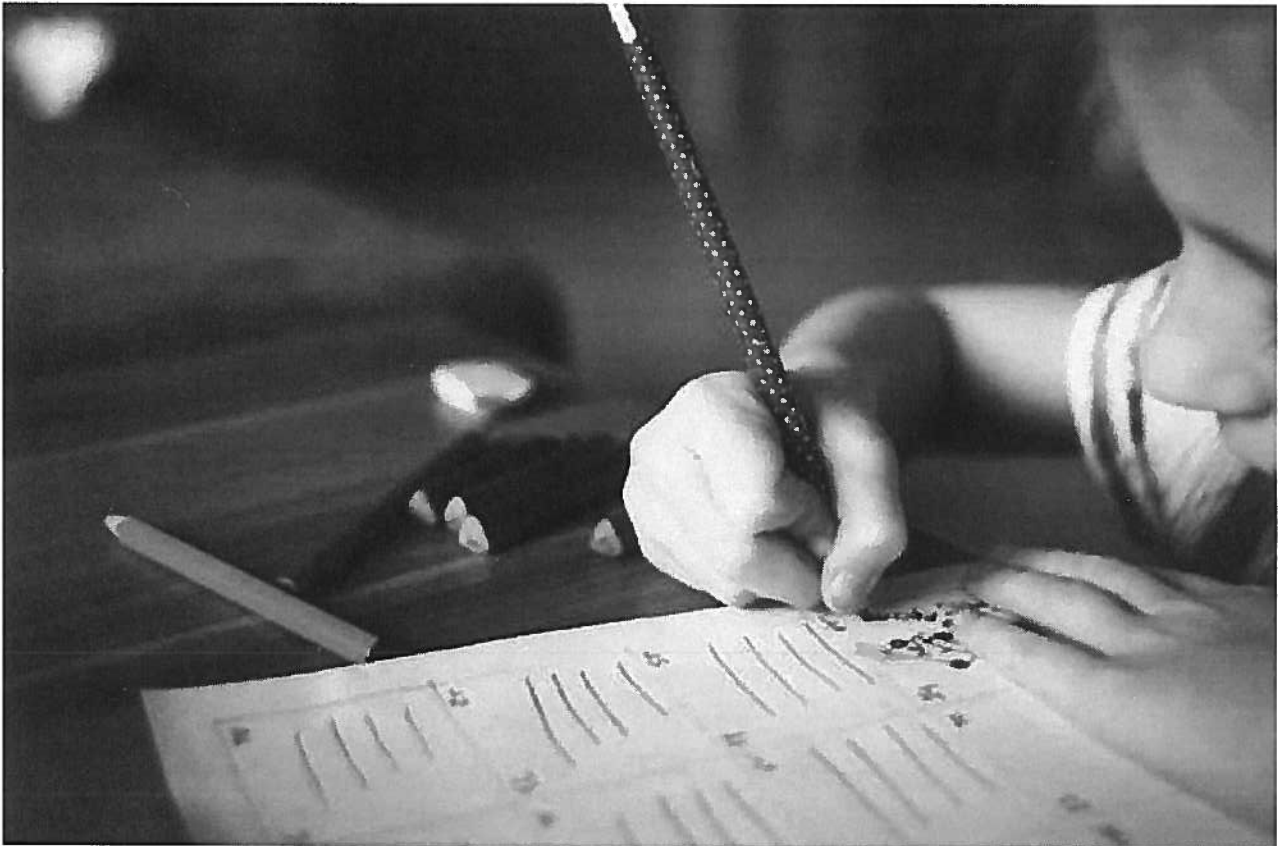

A CHARTER school has been proposed for the Garden Grove Unified School District. The GGUSD board will take up the matter at its meeting on Tuesday night.

Charter schools have been a hot topic in public education in recent years. The Los Angeles Unified School District Board of Education, for example, now has a majority considered supportive of that alternative form of public schooling.

The Garden Grove Unified School District Board of Education will consider the concept at its Dec. 4 meeting. Achievers Global Academy has submitted a petition to open a charter school within district boundaries.

(<https://orangecountytribune.files.wordpress.com/2018/01/usually-reliable-sources1.jpg>) That petition was put forth by Virginia Carrillo, an assistant principal in the Santa Ana Unified School District. A public hearing was held on Oct. 16 and a crowd of about 100 parents attended, registering their opposition to the proposal. The final decision is expected to be made on Dec. 4.

What is a charter school? Generally speaking, they are publically-funded operations, which operate independently of the local education agency. Advocates claim that charters can offer more innovative education and a broader curriculum, while opponents argue they can be anti-union and have limited accountability and oversight.

Charter schools do not charge tuition and cannot exclude students, so are generally not considered private schools. In some parts of the United States, the creation of charter schools were offered as a “school choice” alternative to school voucher programs.

There are around 18 charter schools in Orange County, but none within the boundaries of the GGUSD, which serves most of Garden Grove and portions of Anaheim, Cypress, Fountain Valley, Santa Ana, Stanton and Westminster.

Nearby charter schools include Audeo Charter School in Westminster, which identifies itself as an “independent study academic intervention program” serving students in grades K-12.

Perhaps the best-known charter in Orange County is Samueli Academy in Santa Ana, a high school named after philanthropists Henry and Susan Samueli. Henry is the co-founder of Broadcom Corporation, one of the largest telecommunications corporations in the world. It has gained attention for serving foster children and helping to establish the Orange County High School Esports League, providing organized competition for video game teams.

## They're been close for a long time ...

Much has been made of the recent success of the Western High football team, which grabbed its first CIF-SS title with a win over Peninsula High in the Division 11 championship game last Friday.

But WHS is no stranger to playing at the highest levels of football. The Pioneers were CIF-SS finalists in 1971, 1972, 2003 and 2004. Still playing now in the CIF State Playoffs, the boys from Anaheim could win a California title, which might go a long way toward making up for all the “close but no cigar” results of earlier times.

## Lighting is a Main (Street) Event

A goal of downtown property owners and businesses on Garden Grove's historic Main Street for many years came to brilliant reality on Tuesday night. From Garden Grove Boulevard and Acacia Parkway, the thoroughfare in the city's original central business district was ablaze with electric lights in the trees that line the way.

It was part of a holiday illumination effort that also lit up the city hall and the Gem Theater.

Will the lights on Main Street become a permanent fixture? More on that later.



OC Tribune  
November 28, 2018  
2 of 2



MAIN STREET in Garden Grove is lit up for the holidays (Orange County Tribune photo).

THURSDAY, NOVEMBER 29TH, 2018

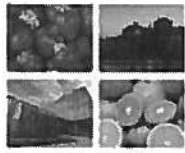

**ORANGE  
COUNTY**

**TRIBUNE**

■ Garden Grove  
■ Huntington Beach  
■ Westminster  
and Orange County

[www.orangecountytribune.com](http://www.orangecountytribune.com) Non-partisan news, opinion, arts and sports. Updated daily.

OC Tribune  
November 27, 2018  
1 of 2

GARDEN GROVE

## “Contingency plan” for fire service backed

BY OC TRIBUNE STAFF ON NOVEMBER 27, 2018 • ( [LEAVE A COMMENT](#) )



**CONTINGENCY PLANS** to keep the Garden Grove Fire Department in case negotiations break down with the Orange County Fire Authority were supported at Tuesday night's city council meeting (GGFD photo).

By Jim Tortolano

On his final full night as a member of the Garden Grove City Council, typically quiet Councilman Kris Beard raised his voice, underlining the idea that the city had not quite made a final decision to replace the municipal fire department with the Orange County Fire Authority.

Beard's motion on Tuesday night to place the matter on the agenda of the Dec. 11 meeting for discussion was defeated on a 4-3 vote. Beard was supported by council colleagues Kim Nguyen and Thu-Ha Nguyen. He wanted to reopen the matter of the increased cost of making the switch.

But all the council members who voted against the motion nevertheless endorsed the concept of the city creating a contingency plan to keep the GGFD in case negotiations with the OCFA broke down.

"I think the numbers have been fudged," said Beard, who was the sole dissenting vote at the Nov. 13 meeting at which the council originally voted to begin talks with the countywide agency. He suggested that a third party mediate between the estimates given the city's finance department – up to \$10 million over 10 years – and those of the Garden Grove Firefighters Association – of about \$275,000 over that same period.

At issue was a "sensitivity analysis" submitted on Nov. 13 that projected labor costs over a decade, with variables of increases ranging from 1 to 5 percent annually.

Beard fenced verbally with Councilman Phat Bui, who said, "We should not bring up something which we have already voted on."

Kim Nguyen's chief concern was the issue of a contingency plan, which she envisioned as an alternate proposal for fire and paramedic services. When the motion was defeated, she said. "You just voted against having a contingency plan."



KRIS BEARD, Garden Grove City Council member (Tribune file photo).

OC Tribune  
November 27, 2018  
2 of 2



([https://orangecountytribune.files.wordpress.com/2016/07/gg-logo\\_lg.jpg](https://orangecountytribune.files.wordpress.com/2016/07/gg-logo_lg.jpg)) But other council members spoke in favor of a backup, even though it was not specifically included in the motion approved at the Nov. 13 meeting.

City Manager Scott Stiles told the council that the city had received no specific contract proposals from the OCFA, and that the municipal staff was proceeding with planning for the alternative of keeping the GGFD. Jones echoed that. "I've always been in favor of a contingency plan," he said. "But two things we're not going to do is hire a new fire chief or enter into negotiations with the firefighters' union," he said.

The Garden Grove Firefighters Association has been the main force advocating for the OCFA to take over the duties now performed by the GGFD. The OCFA provides services for 23 cities in the county, including the neighboring communities of Cypress, Stanton, Westminster and Santa Ana. It's headquartered in Irvine.

But Jones added that the contingency plan would not be viewed as a side-by-side alternative to the OCFA's contract proposal and that it would only come into play if a deal could not be struck with the OCFA.

THURSDAY, NOVEMBER 29TH, 2018

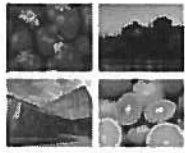

# ORANGE COUNTY TRIBUNE

■ Garden Grove  
■ Huntington Beach  
■ Westminster  
and Orange County

www.orangecountytribune.com Non-partisan news, opinion, arts and sports. Updated daily.

OC Tribune  
November 27, 2018  
1 of 2

GARDEN GROVE

## Fall from G. Grove Freeway injures man

BY OC TRIBUNE STAFF ON NOVEMBER 27, 2018 • ( LEAVE A COMMENT )



A MAN FELL from the Garden Grove Freeway at Beach Boulevard Tuesday afternoon and suffered what were described as "moderate injuries" (GGFD photo).

A man who fell – or jumped – from the Garden Grove Freeway to the street below Tuesday afternoon was taken to a trauma center in stable condition.

According to Capt. Thanh Nguyen of the Garden Grove Fire Department, the incident was reported shortly before 4 p.m. when a California Highway Patrol officer spotted the man hanging from the side of the overpass at Beach Boulevard.

The officer blocked the freeway lanes, and shortly thereafter, the man released his grip and fell over 20 feet to the street.

Garden Grove paramedics treated him for moderate injuries before he was transported to a hospital. No motorists were harmed or injured.

OC Tribune  
November 27, 2018  
2 of 2



# CITY OF GARDEN GROVE NEWS

CONTACT: Sgt. Lino Santana  
(714) 741-5704  
Garden Grove Police Department

## FOR IMMEDIATE RELEASE

Public Information Office (714) 741-5280

Follow the City of Garden Grove on Social Media

Tuesday, November 27, 2018



## STREET CLOSURE DURING 5<sup>TH</sup> ANNUAL JINGLE JAM

On Thursday, December 6, 2018, from 2:00 p.m. to 9:00 p.m., Santa Rita Avenue, between Winton Street and St. Mark Street, will be closed for the 5<sup>th</sup> annual Jingle Jam community event. Vehicles found on the street after 2:00 p.m. will be towed and impounded. No parking signs will be posted prior to the event. Motorists are asked to plan accordingly to avoid delays.

The 5<sup>th</sup> annual Jingle Jam will be held at Eastgate Park, located at 12001 St. Mark Street, from 5:00 p.m. to 8:00 p.m. The event is sponsored by Team Tackney, GMT Real Estate and American Youth Soccer Organization (AYSO) Region 59, West Garden Grove.

Residents in the area have been notified in advance.

The Garden Grove Police Department's Traffic Unit will be on site during closure times to direct traffic and suggest alternate routes.

For more information on the street closure, contact the Garden Grove Police Department at (714) 741-5823.

For more information about the event, visit <http://bit.ly/2PWBoLt>.

###



# CITY OF GARDEN GROVE NEWS

CONTACT:  
Juan Medina (714) 741-5253  
Community Services Department

## FOR IMMEDIATE RELEASE

Public Information Office (714) 741-5280

Follow the City of Garden Grove on Social Media



Tuesday, November 27, 2018

### **H. LOUIS LAKE SENIOR CENTER HOSTS FREE HOLIDAY MOVIE**

The City's H. Louis Lake Senior Center will host a free movie day on Tuesday, December 11, 2018, starting at 9:45 a.m., in the Senior Center Dining Room, located at 11300 Stanford Avenue.

All seniors are invited to enjoy munchies and the Disney movie, "Christopher Robin," starring Ewan McGregor and Hayley Atwell. The movie is about a working-class family man, Christopher Robin, who encounters his childhood friend Winnie-the-Pooh. The movie is rated PG for some action.

For more activities and monthly programs, please call the H. Louis Lake Senior Center at (714) 741-5253 between the hours of 8:00 a.m. and 3:30 p.m., Monday through Friday.

# # #





# CITY OF GARDEN GROVE NEWS

CONTACT: Mark Freeman  
Community Services Department  
(714)741-5212

## FOR IMMEDIATE RELEASE

Public Information Office (714) 741-5280

Follow the City of Garden Grove on Social Media

Monday, November 26, 2018



### **CELEBRATE THE HOLIDAYS WITH "WINTER IN THE GROVE" EVENT DECEMBER 1**

Get ready to experience holiday sights, sounds, and activities at this year's Winter in the Grove, where Winterfest and Christmas Tree Lighting come together into one event. The free event takes place on Saturday, December 1, 2018, from 4:00 p.m. to 8:00 p.m., at Village Green Park, 12732 Main Street.

Activities at the event include a children craft area, holiday refreshments, letters to Santa, balloon animal artist, bounce houses, and eight snow slides made of over 40 tons of snow. Unlimited snow slides are \$5 for a wrist band. Wrist bands can be pre-purchased online at [www.ggcity.org/register](http://www.ggcity.org/register) or the day-of at the event.

Food will be available for purchase from local non-profits. The Boy Scouts of America Troop 270 will be selling "chilly dogs," Fundación Jalisco USA will be selling tamales, and Buena Clinton's Concilio de Padres will be selling pan dulce and coffee. C & M will be selling kettle corn and lemonade. Free hot cocoa, provided by Kiwanis of Greater Garden Grove, and cookies, donated by 7-Eleven, will be available.

Pre-show entertainment begins at 5:00 p.m., provided by Saint Columban School. The 5:30 p.m. program line-up includes performances by the Learning Spot; Christ Cathedral Academy Advance Choir; Trinity Christian School;

-more-

Celebrate The Holidays With The Winter In The Grove Event December 1  
2-2-2

the Voice of Garden Grove 2018 runner-up, Jessica Torres; Foundations Dance  
Company; and Bolsa Grande High School Concert Choir.

After the performances, the Garden Grove City Council will light the 24-foot  
Christmas tree. The event culminates with the arrival of Santa and Mrs. Claus.

For more information, visit [www.ggcity.org/community-services/winter-grove](http://www.ggcity.org/community-services/winter-grove)

###

Để phổ biến trên các phương tiện truyền thông  
Văn phòng thông tin liên lạc: (714) 741-5280

Liên lạc: Gabi O'Cadiz-Hernandez  
(714) 741-5769  
Ban Phục Vụ Cộng đồng



Thứ Năm, 29 tháng 11, 2018

### **MANG NIỀM VUI ĐẾN CÁC GIA ĐÌNH TRONG CỘNG ĐỒNG BẰNG CÁCH THAM GIA CHƯƠNG TRÌNH 'GARDEN GROVE'S HOLIDAY DRIVE'**

Các trung tâm hỗ trợ cộng đồng trong Thành phố Garden Grove kêu gọi sự đóng góp cho chương trình 'Garden Grove Holiday Drive 2018' nhằm mang lại niềm vui, hy vọng và tinh thần trong mùa lễ cho các trẻ em và gia đình gặp hoàn cảnh khó khăn. Các trung tâm đang nhận sự quyên góp từ bây giờ đến Thứ Sáu, ngày 14 tháng 12, 2018.

Hai trung tâm hỗ trợ cộng đồng tại Garden Grove là Trung tâm 'Buena Clinton Youth and Family Center' và Trung tâm 'Magnolia Park Family Resource Center.' Cả hai trung tâm cung cấp cho cư dân Garden Grove những dịch vụ cộng đồng quan trọng, bao gồm các chương trình miễn phí hoặc với lệ phí thấp tập trung vào việc huấn luyện và tư vấn thanh thiếu niên, các dịch vụ hỗ trợ gia đình và giáo dục nuôi dạy con cái. Năm ngoái, với sự hỗ trợ từ cộng đồng, các trung tâm đã giúp đỡ hơn 300 gia đình tại Garden Grove, tặng quà đến hơn 900 trẻ em kém may mắn để có một mùa lễ hội trọn vẹn.

Mọi người có thể đóng góp tiền mặt, thẻ quà tặng (gift cards), đồ chơi, đồ ăn đóng hộp, board games, và các khoản quyên góp khác được thu nhận tại các địa điểm sau đây:

**MANG NIỀM VUI ĐẾN CÁC GIA ĐÌNH TRONG CỘNG ĐỒNG....**

Trang 2

Trung tâm 'Buena Clinton Youth and Family Center': 12661 Sunswapt Avenue

Trung tâm 'Magnolia Park Family Resource Center': 11402 Magnolia Street

Tòa Thị Chính Garden Grove – Recreation Counter: 11222 Acacia Parkway

Chi phiếu xin để cho 'Garden Grove Community Foundation' và gửi về:

Holiday Drive, c/o GGCF, P.O. Box 3070, Garden Grove, CA 92842. Biên nhận khấu trừ thuế có sẵn theo yêu cầu.

Để biết thêm thông tin chương trình 'Garden Grove Holiday Drive 2018' hoặc các trung tâm phục vụ cộng đồng trong Thành phố, vui lòng liên lạc với cô Vicky Casillas tại [vickyc@ggcity.org](mailto:vickyc@ggcity.org) hoặc gọi số (714) 741-5208.

# # #



# THÔNG TIN

## Từ Thành Phố Garden Grove

Để phổ biến trên các phương tiện truyền thông  
Văn phòng thông tin liên lạc: (714) 741-5280

Liên lạc: Mark Freeman, (714) 741-5212  
Ban Phục Vụ Cộng đồng



Thứ Ba, 27 tháng 11, 2018

### **THÀNH PHỐ GARDEN GROVE MANG ĐẾN CỘNG ĐỒNG CHƯƠNG TRÌNH 'WINTER IN THE GROVE' NGÀY 1 THÁNG 12 SẮP TỚI**

Vào mùa đông năm nay, Ban Phục Vụ Cộng đồng sẽ mang đến chương trình "Winter in the Grove" và được tổ chức vào ngày Thứ Bảy, 1 tháng 12, 2018, tại Village Green Park, tọa lạc tại 12732 Main Street, từ 4:00 giờ chiều tới 8:00 giờ tối. Đây là lần đầu tiên Thành phố hợp hai chương trình 'Winterfest' và 'Christmas Tree Lighting' vào một.

Các chương trình và trò chơi có tại sự kiện này bao gồm một khu vực thủ công dành cho trẻ em, viết thư gửi cho ông già Noel, bounce house, và đặc biệt là hơn 40 tấn tuyết để dành chơi trượt tuyết (snow slides) với lệ phí là \$5. Mọi người có thể lên online tại [www.ggcity.org/register](http://www.ggcity.org/register) để mua vòng đeo (wrist band) tham gia trò chơi trượt tuyết vào ngày tổ chức sự kiện.

Các thức ăn nhẹ sẽ được bán bởi những hội đoàn bất vụ lợi trong cộng đồng. Mọi người sẽ được phục vụ miễn phí nước uống cocoa nóng, được bảo trợ bởi Kiwanis of Greater Garden Grove, và bánh cookies, được bảo trợ bởi 7-Eleven.

## **THÀNH PHỐ GARDEN GROVE MANG ĐẾN CỘNG ĐỒNG...**

Trang 2

Chương trình văn nghệ sẽ được bắt đầu lúc 5:00 chiều, bắt đầu với trường Saint Columban. Vào lúc 5:30 sẽ là phần trình diễn đặc sắc bởi Christ Cathedral Academy Advance Choir; trường Trinity Christian; quán quân chương trình 'The Voice of Garden Grove 2018', Jessica Torres; Foundation Dance Company; và ban hợp ca trường trung học Bolsa Grande High School. Sau buổi biểu diễn, Hội đồng thành phố Garden Grove sẽ thắp sáng cây Giáng sinh dài 24 foot. Chương trình sẽ có sự xuất hiện của ông già Noel và bà Claus.

Để biết thêm chi tiết, xin coi tại trang

[www.ggcity.org/community-services/winter-grove](http://www.ggcity.org/community-services/winter-grove).

# # #

Garden Grove Mời Dự Chương Trình 'Winter In The Grove' Ngày 1 Tháng 12 Năm 2018 Sắp Tới

28/11/2018 00:00:00





The best of *Winterfest* AND *Christmas Tree Lighting* in one exciting new event

*Saturday, December 1, 2018*  
 4:00 p.m. - 8:00 p.m.  
 Village Green Park  
 12732 Main Street, Garden Grove

*Holiday Refreshments and Kids' Activities*  
 Food available for purchase



\$5 Unlimited Snow Slides



GGCF Spectacular Tree Lighting



Visit Santa & Mrs. Claus

[www.ggcity.org](http://www.ggcity.org)  
 (714) 741-5200





Vào mùa đông năm nay, Ban Phục Vụ Cộng đồng sẽ mang đến chương trình "Winter in the Grove" và được tổ chức vào ngày Thứ Bảy, 1 tháng 12, 2018, tại Village Green Park, tọa lạc tại 12732 Main Street, từ 4:00 giờ chiều tới 8:00 giờ tối. Đây là lần đầu tiên Thành phố hợp hai chương trình "Winterfest" và "Christmas Tree Lighting" vào một.

Các chương trình và trò chơi có tại sự kiện này bao gồm một khu vực thủ công dành cho trẻ em, viết thư gửi cho ông già Noel, bounce house, và đặc biệt là hơn 40 tấn tuyết để dành chơi trượt tuyết (snow slides) với lệ phí là \$5. Mọi người có thể lên online tại [www.ggcity.org/register](http://www.ggcity.org/register) để mua vòng đeo (wrist band) tham gia trò chơi trượt tuyết vào ngày tổ chức sự kiện.

Các thức ăn nhẹ sẽ được bán bởi những hội đoàn bất vụ lợi trong cộng đồng. Mọi người sẽ được phục vụ miễn phí nước uống cocoa nóng, được bảo trợ bởi Kiwanis of Greater Garden Grove, và bánh cookies, được bảo trợ bởi 7-Eleven.

Chương trình văn nghệ sẽ được bắt đầu lúc 5:00 chiều, bắt đầu với trường Saint Columban. Vào lúc 5:30 sẽ là phần trình diễn đặc sắc bởi Christ Cathedral Academy Advance Choir; trường Trinity Christian; quán quân chương trình "The Voice of Garden Grove 2018", Jessica Torres; Foundation Dance Company; và ban hợp ca trường trung học Bolsa Grande High School. Sau buổi biểu diễn, Hội đồng thành phố Garden Grove sẽ thắp sáng cây Giáng sinh dài 24 foot. Chương trình sẽ có sự xuất hiện của ông già Noel và bà Claus.

Để biết thêm chi tiết, xin coi tại trang

[www.ggcity.org/community-services/winter-grove](http://www.ggcity.org/community-services/winter-grove).

- Người Đẹp Đó Đây
- 3787 Bốn Vĩ Dân Cử Vào Dòng Chính Tại Thành Phố Westminster Vừa Được Tín Nhiệm Tạ Ôn Cử Tri Và Vinh Danh Cộng Đồng
- Thông Tin Thẻ Tín Dụng Ở Hilton Bj Trộm
- Có Thể BỊ Chung Thân Vụ Lạm Dụng Sex Ở Boston



## **MISCELLANEOUS ITEMS**

**November 29, 2018**

1. Calendar of Events
2. Agenda for the December 6, 2018 Planning Commission meeting.
3. League of California Cities "CA Cities Advocate" dated November 22 – November 29, 2018.



**GARDEN GROVE**

## CALENDAR OF EVENTS

November 29, 2018 – December 24, 2018

---

Thursday	November 29		Casual Day – Holiday Drive
Thursday-Sunday	November 29-December 2		One More Productions presents “The Holiday Gem” Gem Theater
Saturday	December 1	4:00 pm-8:00 pm	Winter in the Grove – Winterfest and Christmas Tree Lighting Ceremony, Village Green Park
Monday	December 3	6:30 p.m.	Neighborhood Improvement and Conservation Commission Meeting, Council Chamber
Thursday	December 6	7:00 p.m.	Planning Commission Meeting, Council Chamber
Thursday-Sunday	December 6-December 9		One More Productions presents “The Holiday Gem” Gem Theater
Friday	December 7		City Hall Closed – Regular Friday Closure
Tuesday	December 11	9:45 a.m.	H. Louis Lake Senior Center’s Free Holiday Movie Senior Center Dining Room
		5:30 p.m.	Closed Session, Founders Room
		6:30 p.m.	Successor Agency Meeting, Council Chamber
		6:30 p.m.	City Council Meeting, Council Chamber
Thursday	December 13		Casual Day – Holiday Drive
		9:00 a.m.	Zoning Administrator Meeting City Hall, 3 <sup>rd</sup> Floor Training Room
Thursday-Sunday	December 13-December 16		One More Productions presents “The Holiday Gem” Gem Theater
Thursday	December 20		Casual Day
Friday	December 21		City Hall Closed – Regular Friday Closure
Monday-Tuesday	December 24-January 1		City Hall Closed – Holiday Closure

# League-Sponsored Bond Agency Issues Nearly \$16.5 Million in Tax-Exempt Bonds for Affordable Housing in Los Angeles

*November 26, 2018*

Some of the most significant benefits of League membership for cities since 1988 have flowed from the League's co-sponsorship of the California Statewide Communities Development Authority (CSCDA).

The California Statewide Communities Development Authority (CSCDA) announced the issuance of \$16,500,000 in tax-exempt multifamily affordable housing bonds for LA78 Apartments in Los Angeles.

## **About LA78 Apartments**

LA78 Apartments is the acquisition and rehabilitation of 78 scattered site multi-family affordable housing apartments by LA78, LP. The project sponsor is Community Development Partners (CDP). The project will continue to be 100 percent affordable and provide apartments to low-income residents in Los Angeles.

CSCDA and CDP partnered with Berkadia Commercial Mortgage and Orrick, Herrington & Sutcliffe, LLP to provide the \$16,500,000 in tax-exempt multi-family affordable housing bonds for the project. The project will undergo an extensive interior and exterior renovation ensuring that residents have an updated, safe, and affordable community to call home for years to come. The financing of the project will maintain the affordability of units for low-income tenants for 55 years.

## **About CSCDA**

CSCDA is a joint powers authority created in 1988 and is sponsored by the League of California Cities® and the California State Association of Counties. It was created by cities and counties for cities and counties. More than 530 cities, counties and special districts are program participants in CSCDA, which serves as their conduit issuer and provides access to efficiently finance locally-approved projects. CSCDA has issued more than \$60 billion in tax exempt bonds for projects that provide a public benefit by creating jobs, affordable housing, healthcare, infrastructure, schools and other fundamental services. Visit [CSCDA's website](#) for additional information on the ways in which CSCDA can help your city.

# Legislature to Convene for Brief Organization Session on Dec. 3 to Start 2019–20 Session

Gov. Gavin Newsom will take office and release proposed budget week of Jan. 7

*November 26, 2018*

The Senate and Assembly will convene on Monday, Dec. 3, to organize their respective houses, elect leadership, adopt house rules and introduce initial bills for the 2019–20 Legislative Session.

While remaining votes continue to be counted that may affect close races, it is clear that Democrats will hold supermajorities (more than two-thirds) in both houses with potentially 29 out of 40 seats in the Senate and at least 60 out of 80 seats in the Assembly.

Senate and Assembly leadership is expected to remain the same with Sen. Toni Atkins (D-San Diego) as President pro Tempore of the Senate and Assembly Member Anthony Rendon (D-Lakewood) as Assembly Speaker. Senate Republican Leader Pat Bates (R-Laguna Niguel) is expected to remain in her role and Assembly Member Marie Waldron was recently elected by her caucus as Assembly Republican Leader.

Roughly around 100 bills are also introduced in this initial session. The 2019 legislative year promises to be extremely busy with numerous policy proposals expected from the new Governor, including proposals addressing affordable housing, homelessness challenges and wildfires. Links to Governor-elect Gavin Newsom's platforms can be found on his [website](#).

Following this organizing session, legislators and staff will be busy submitting bill requests to the Legislative Counsel by Jan. 25 to meet the Feb. 22 bill introduction deadline for the year. Legislative policy committees ramp up typically in March, but informational hearings begin early in the year. A tentative 2019 Legislative calendar can be found in the attached most recent [Senate File](#).

## **Gavin Newsom Begins First Year of His First Term as Governor; Healthy Budget Expected**

This January will bring the first of many firsts for Governor-Elect Newsom who starts his inaugural year as Governor when he is sworn into office on Jan. 7. Several days later, Jan. 10 is the constitutional deadline for the Governor to release his proposed FY 2019–20 budget. The Legislative Analyst's Office in November issued its [FY 2019–20 fiscal outlook](#), touting the how the budget is in "remarkably good shape" and projecting that the State of California will have \$14.5 billion in reserves at the end of the coming fiscal year without any new spending commitments that expand the state's financial obligations. Governor-Elect Newsom will also deliver his State of the State Address to the Legislature in early 2019.

## League Activities in January

The League's leadership for 2019 is:

- President Jan Arbuckle, council member, Grass Valley;
- First Vice President Randon Lane, council member, Murrieta;
- Second Vice President John Dunbar, mayor, Yountville; and
- Immediate Past President Rich Garbarino, council member, South San Francisco.

League members will be in Sacramento in January for a number of key events to launch the year.

### **New Mayors and Council Members Academy, (Sacramento, Jan. 16 – 18) and (Irvine, Jan. 30 – Feb. 1.)**

– The New Mayors and Council Members Academy, being held Jan. 16 – 18 in Sacramento, will cover the basic legal and practical framework in which city officials operate. The conference is designed for both newly elected officials and veterans on city councils. To ensure more city officials have access to this important training, the League is adding a Southern California New Mayors and Council Members Academy in Irvine, Jan. 30 – Feb. 1.

Register [online](#) for either session.

**Sacramento Legislative Reception** – On Wednesday, Jan. 16, the League will hold its annual Legislative Reception in Sacramento, which brings together city officials, senators, assembly members, constitutional officers and others for networking. The reception will be at Cafeteria 15L from 5:30 to 6:30 p.m.

**League Policy Committees** – League policy committees will also meet Jan. 17–18 in Sacramento to begin discussion on key policy proposals, hear from expert speakers and receive an update on the Governor's proposed FY 2019–20 budget. Policy committee meeting information can be found on the League's [website](#).



## AGENDA

### GARDEN GROVE PLANNING COMMISSION

#### REGULAR MEETING

---

DECEMBER 6, 2018

COMMUNITY MEETING CENTER  
11300 STANFORD AVENUE

#### REGULAR SESSION – 7:00 P.M. – COUNCIL CHAMBER

ROLL CALL: CHAIR BRIETIGAM, VICE CHAIR TRUONG  
COMMISSIONERS KANZLER, LAZENBY, LEHMAN, NGUYEN,  
SALAZAR

Members of the public desiring to speak on any item of public interest, including any item on the agenda except public hearings, must do so during Oral Communications at the beginning of the meeting. Each speaker shall fill out a card stating name and address, to be presented to the Recording Secretary, and shall be limited to five (5) minutes. Members of the public wishing to address public hearing items shall do so at the time of the public hearing.

Any person requiring auxiliary aids and services due to a disability should contact the City Clerk's office at (714) 741-5035 to arrange for special accommodations. (Government Code §5494.3.2).

All revised or additional documents and writings related to any items on the agenda, which are distributed to all or a majority of the Planning Commissioners within 72 hours of a meeting, shall be available for public inspection (1) at the Planning Services Division during normal business hours; and (2) at the City Community Meeting Center Council Chamber at the time of the meeting.

Agenda item descriptions are intended to give a brief, general description of the item to advise the public of the item's general nature. The Planning Commission may take legislative action it deems appropriate with respect to the item and is not limited to the recommended action indicated in staff reports or the agenda.

#### PLEDGE OF ALLEGIANCE TO THE FLAG OF THE UNITED STATES OF AMERICA

- A. ORAL COMMUNICATIONS - PUBLIC
- B. APPROVAL OF MINUTES: November 15, 2018
- C. PUBLIC HEARING(S) (Authorization for the Chair to execute Resolution shall be included in the motion.)
  - C.1. PLANNED UNIT DEVELOPMENT NO. PUD-103-82 (REV. 2018)

APPLICANT: ELECTRA-MEDIA, INC. (EMI)

LOCATION: SOUTH SIDE OF TRASK AVENUE, WEST OF  
BROOKHURST STREET AT 9444 AND 9670 TRASK  
AVENUE

**REQUEST:** A request for Planning Commission recommendation to City Council to amend PUD-103-82 to reconstruct an existing on-premise freeway-oriented static and digital sign and increase the digital display area from 298.47 square feet to 477 square feet for Toyota Place automobile dealership. The site is in the PUD-103-82 (Planned Unit Development) zone.

**STAFF RECOMMENDATION:** Recommend approval of Planned Unit Development No. PUD-103-82 (REV. 2018) to City Council. In conjunction, the Planning Commission will make a recommendation to City Council to consider a determination that the project is categorically exempt from the California Environmental Quality Act (CEQA) pursuant to Section Nos. 15311 – Accessory Structures and 15061(b)(3) – Review for Exemption – of the State CEQA Guidelines.

- D. MATTERS FROM COMMISSIONERS
- E. MATTERS FROM STAFF
- F. ADJOURNMENT