

TRAFFIC ENGINEERING
POLICY TE 14

TURNING TEMPLATE

GENERAL STATEMENT

The pavement and roadway widths of turning roadways at intersections are governed by the volumes of turning traffic and types of vehicles to be accommodated. The turning radii and pavement cross slopes are functions of design speed and the type of vehicles.

POLICY

Where it is necessary to provide for turning vehicles within a minimum space, the minimum turning paths of the design vehicles apply. Sharpest turns of design vehicles are provided in the attached turning templates. The paths indicated, which are slightly greater than the minimum paths of nearly all vehicles in each class, are the minimum attainable at speed less than 10 mph, and consequently offer some leeway in driver behavior. Layouts patterned to fit these paths of design vehicles are considered satisfactory as a minimum design.

In using these templates, it is assumed that the vehicle is properly positioned within the traffic lane at the beginning and end of the turn; i.e., two feet from edge of pavement on the tangents approaching and leaving the curve. This assumption closely fits the inter wheel paths of the various design vehicles. Differences in the inter path of vehicles turning left and right are not sufficient to be significant in design.

In conclusion, corner radii at intersections on arterial streets should satisfy the requirements of drivers using them to the extent practical. The following summary is offered as a guide:

1. Radii of 15 to 25 feet are adequate for passenger vehicles. These radii may be provided at minor cross streets where there is little occasion for trucks to turn or a major intersection where there are parking lanes.
2. Radii of 25 feet or more at minor cross streets should be provided on new construction and reconstruction where space permits.
3. Radii of 30 feet or more at major cross streets should be provided where feasible so that an occasional truck can turn without too much encroachment.
4. Radii of 40 feet or more, and preferably these centered compound curves or simple curves with tapers to fit the paths of appropriate design vehicles, should be provided where large truck combinations and buses turn frequently. Larger radii are also desirable where speed reductions would cause problems.
5. Radii dimensions should be coordinated with crosswalk distances or special designs to make crosswalks safer for pedestrians, the aged and the handicapped.

POLICY TE 15 (Continued)

Curb radii at corners on two-way streets have little effect on left-turning movements. Where the width of an arterial street is equivalent to four or more lanes, generally there is no problem or encroachment by left-turning vehicles.



11

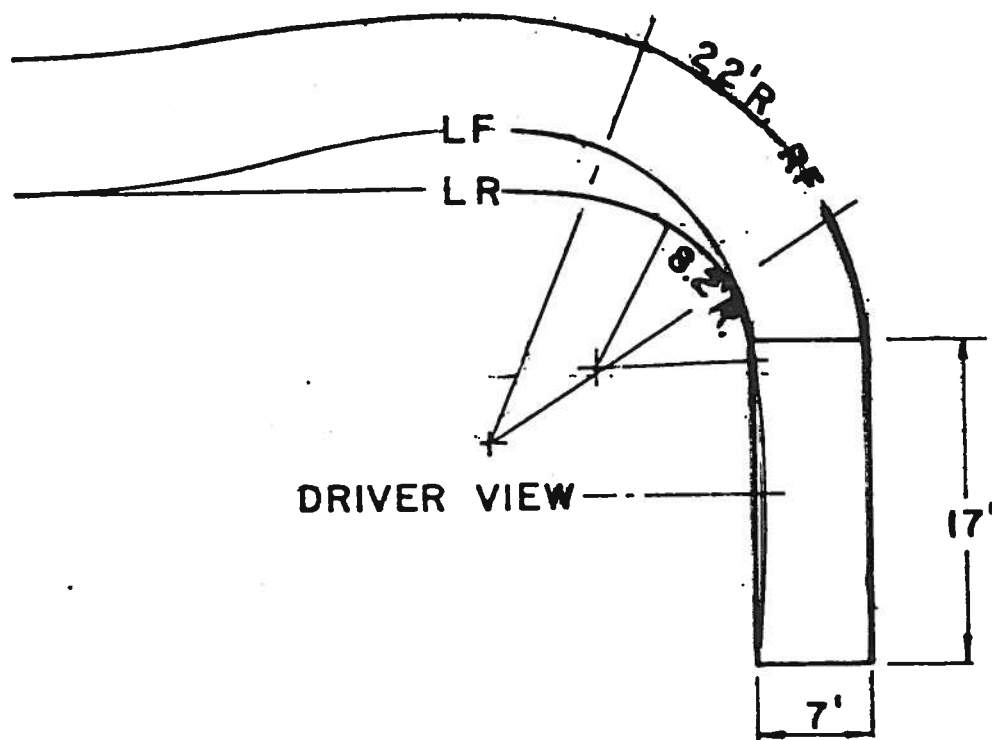

FOUR DOOR SEDAN
 TURNING RADIUS
 SCALE 1" = 10'

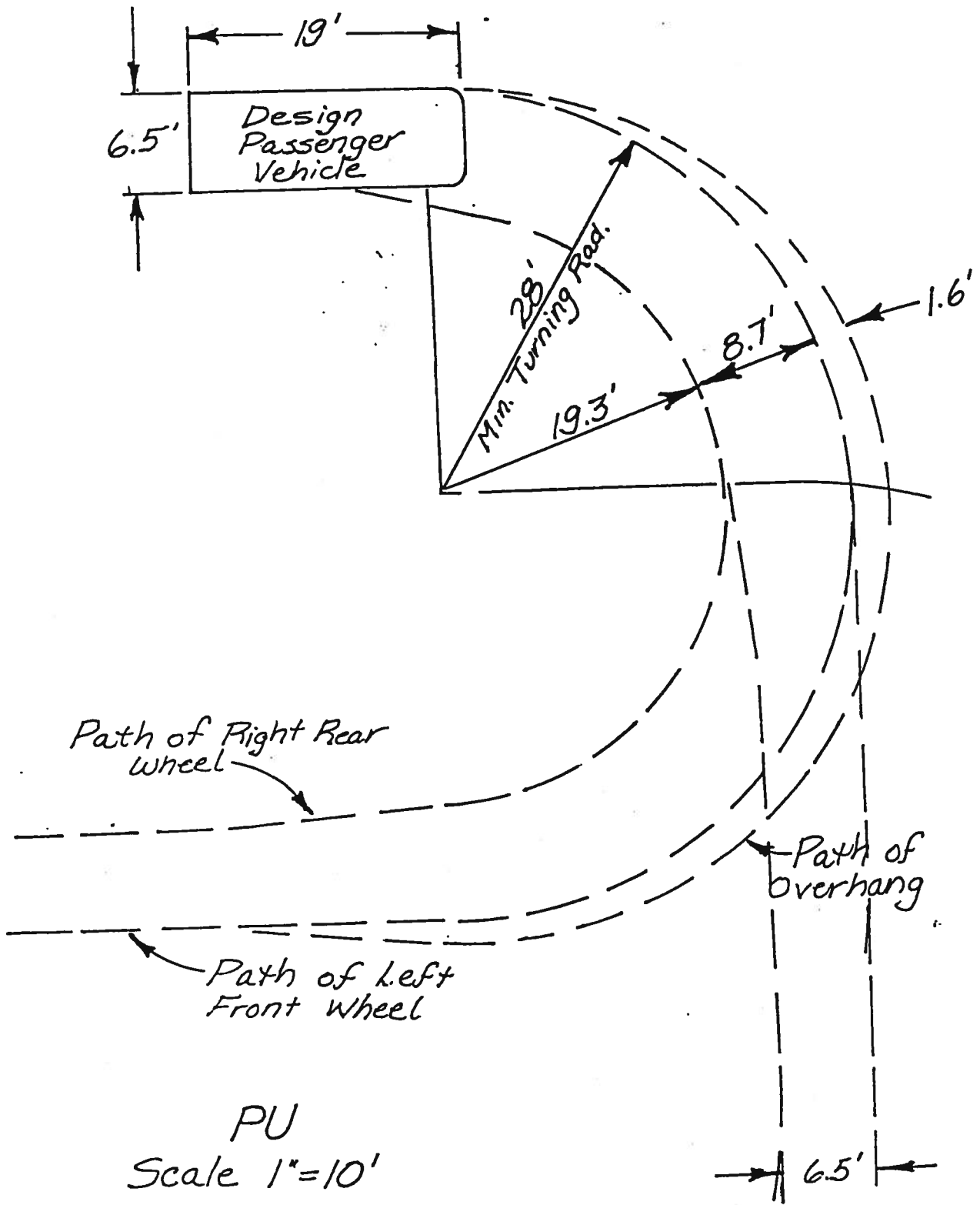

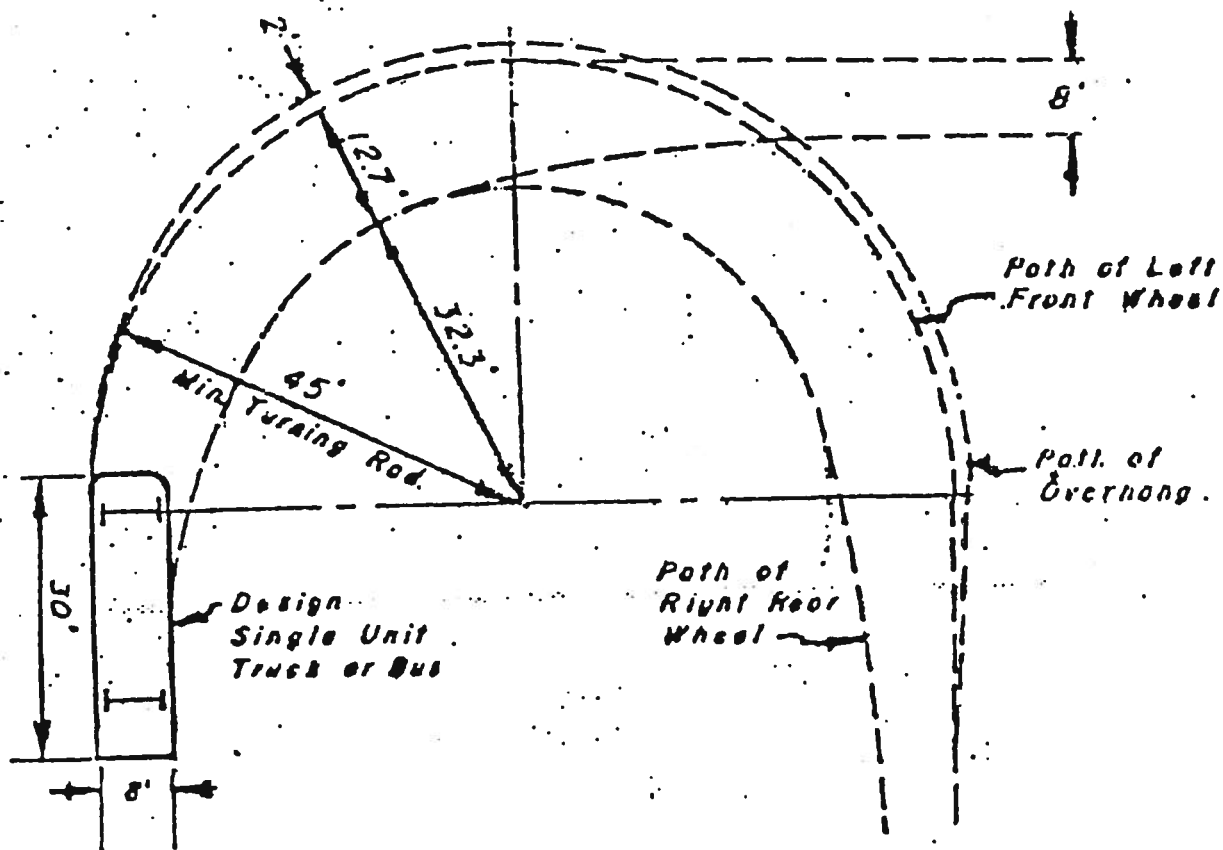

**SINGLE UNIT TRUCK or BUS
DESIGN VEHICLE (2)**

SCALE 1" = 20'

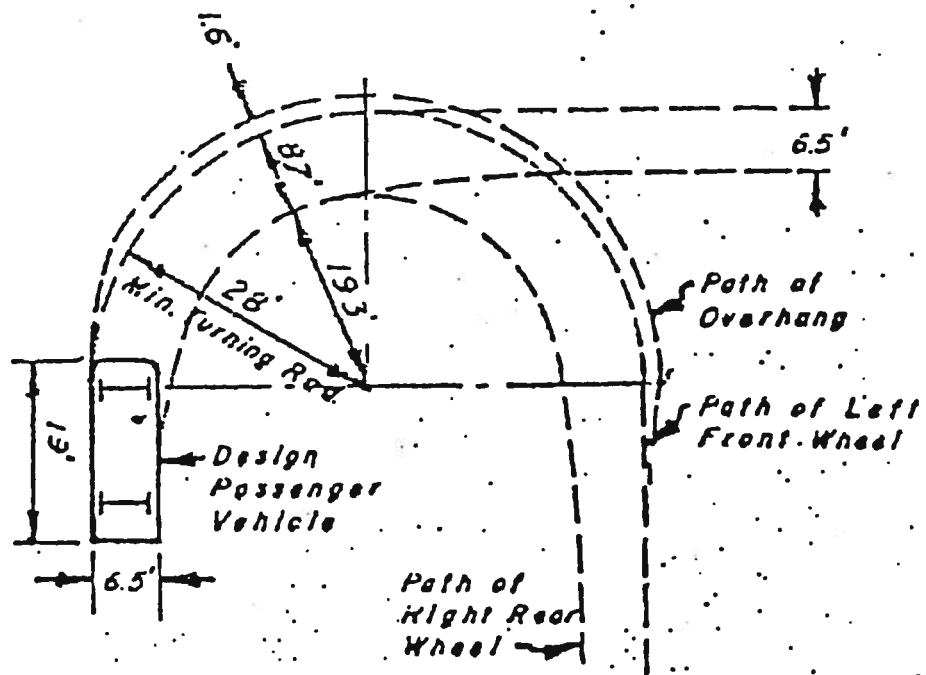

PASSENGER
 DESIGN VEHICLE (1)

Scale 1"=20'

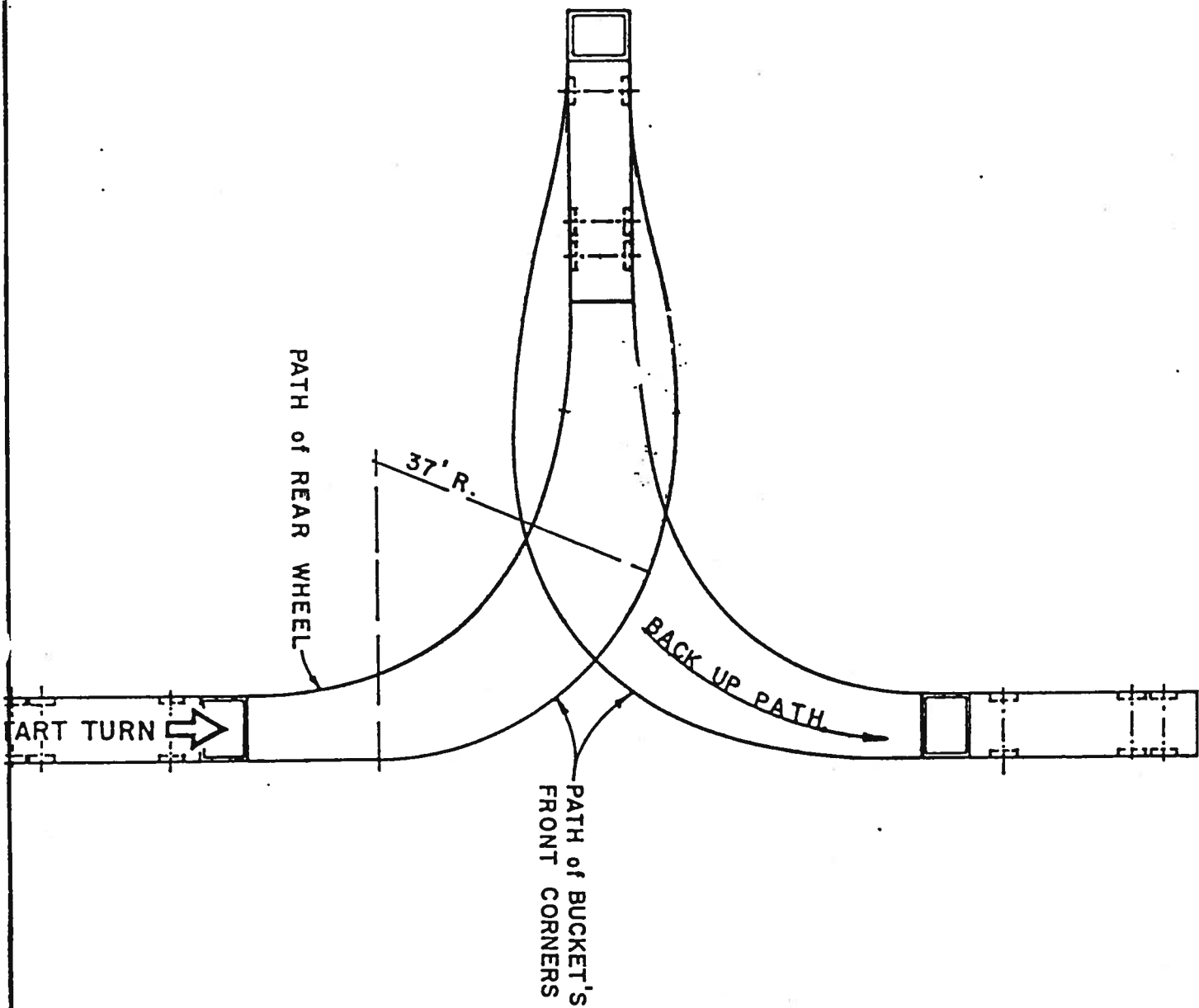

SCALE 1" = 20'

TRUCK TURNING RADIUS
35' LONG TRASH TRUCK

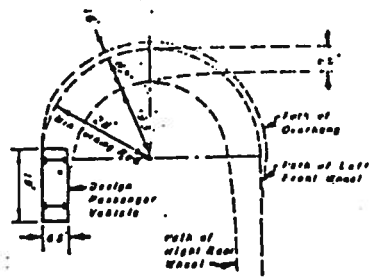

**PASSENGER
DESIGN VEHICLE (1)**

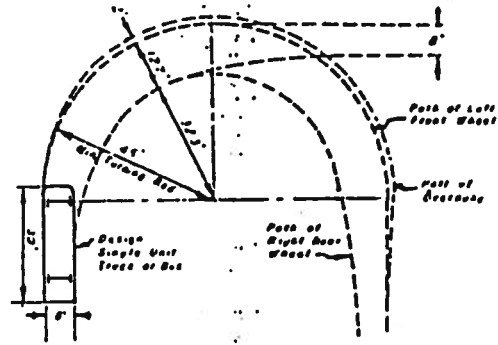

**SINGLE UNIT TRUCK or BUS
DESIGN VEHICLE (2)**

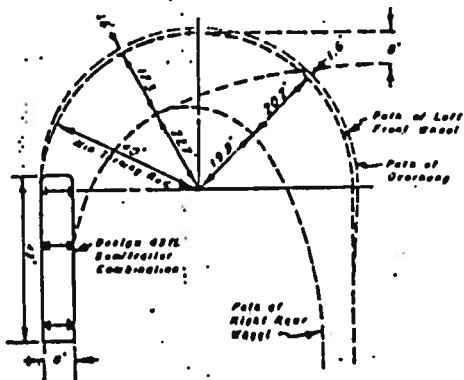

**43ft. SEMITRAILER COMB
DESIGN VEHICLE (3)**

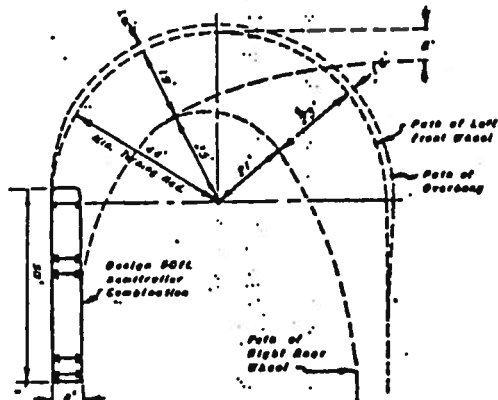

**50ft. SEMITRAILER COMB.
DESIGN VEHICLE (4)**

SCALE 1" = 50'

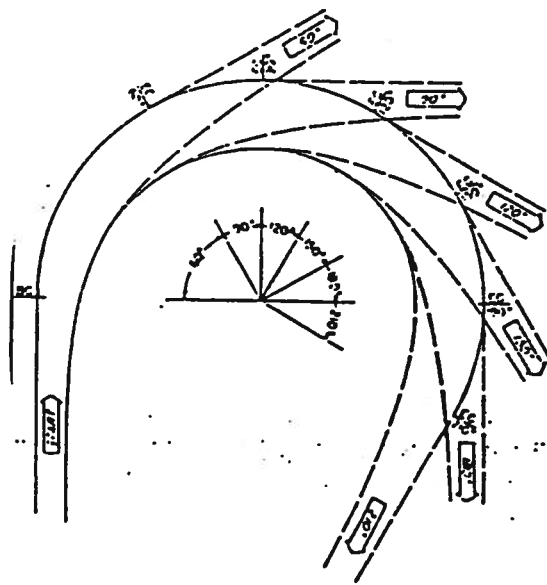

SEMITRAILER WHEEL TRACKS
58' RADIUS

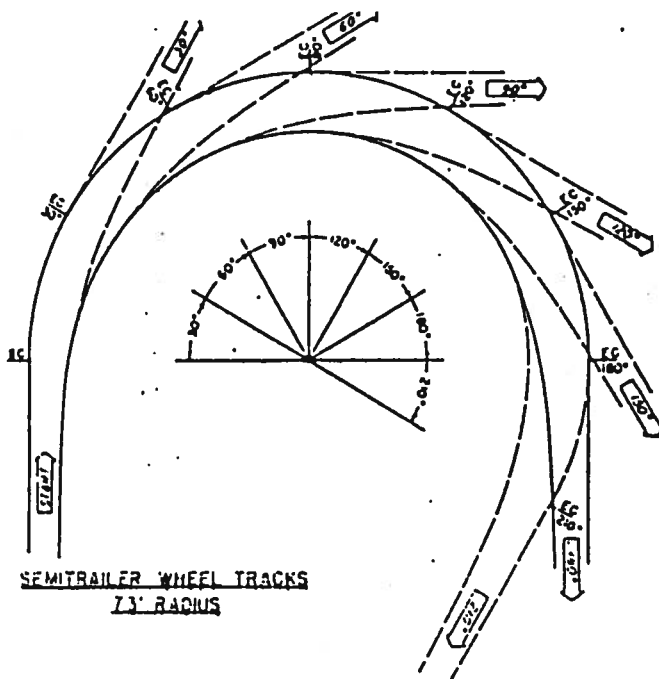

SEMITRAILER WHEEL TRACKS
73' RADIUS

SCALE 1" = 5.0'

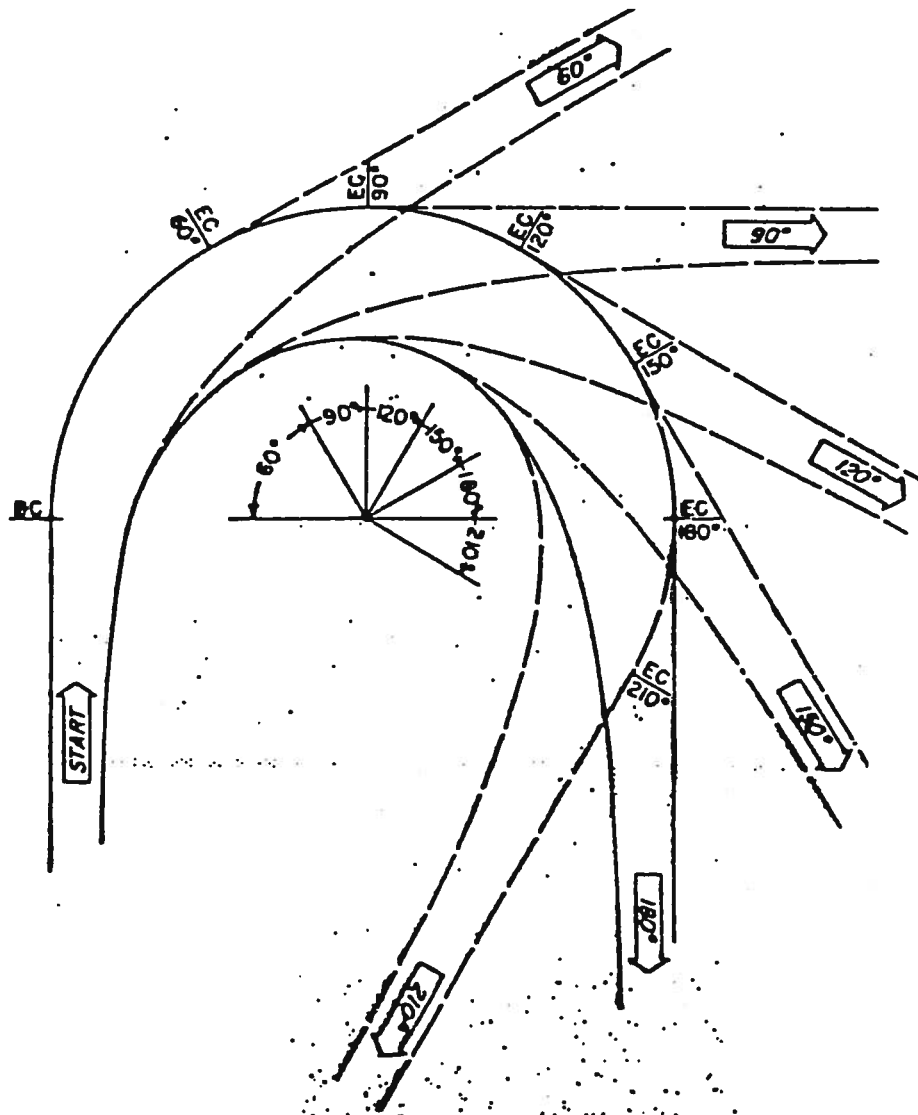

SEMITRAILER WHEEL TRACKS
48' RADIUS

SCALE 1" = 30'

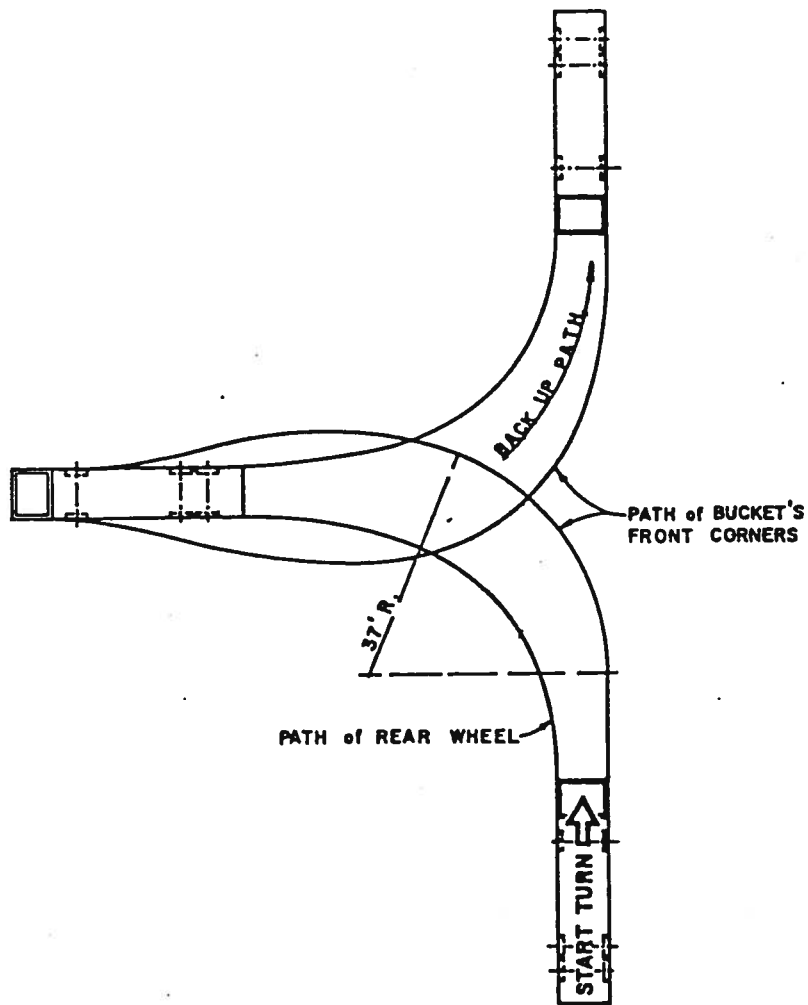

TRUCK TURNING RADIUS
35' LONG TRASH TRUCK

SCALE 1" = 30'

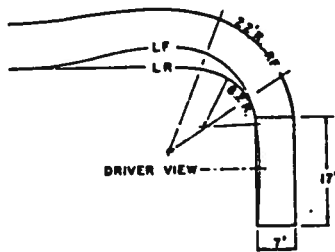

**FOUR DOOR SEDAN
TURNING RADIUS**

SCALE 1" = 30'

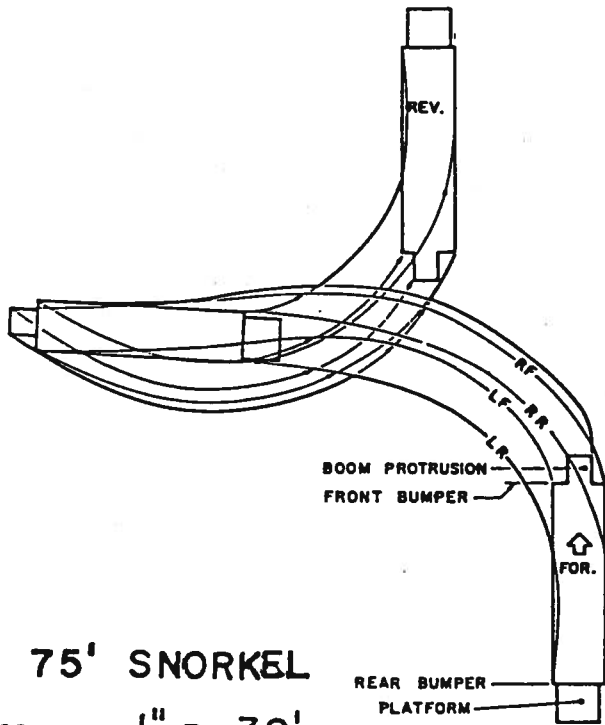
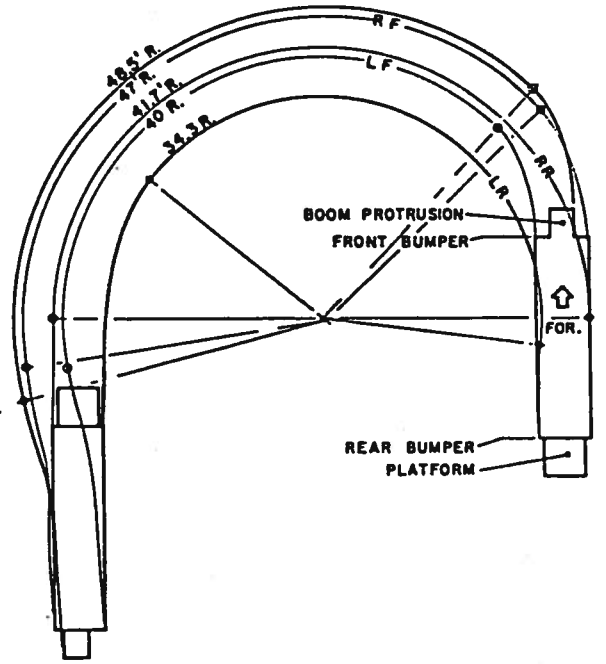
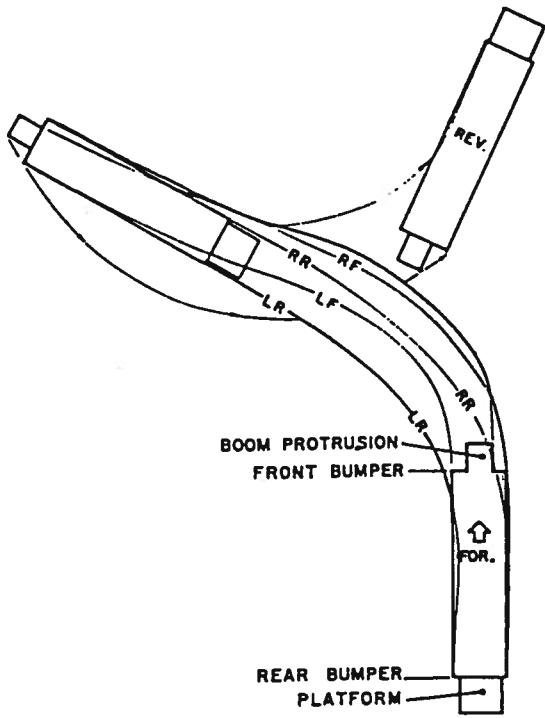

75' SNORKEL
SCALE 1" = 30'

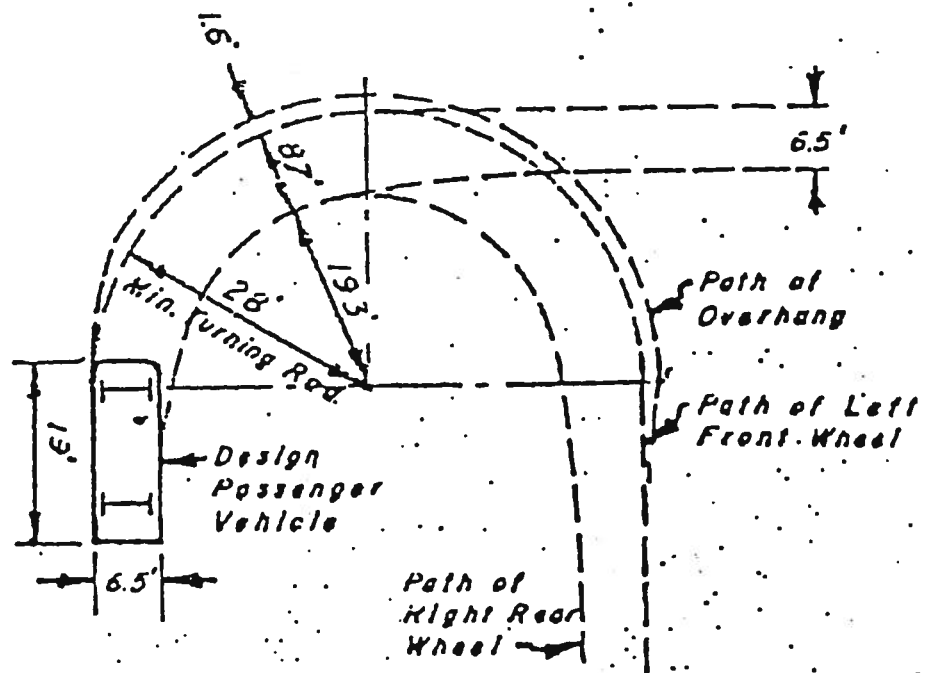

PASSENGER
DESIGN VEHICLE (1)

Scale 1"=20'

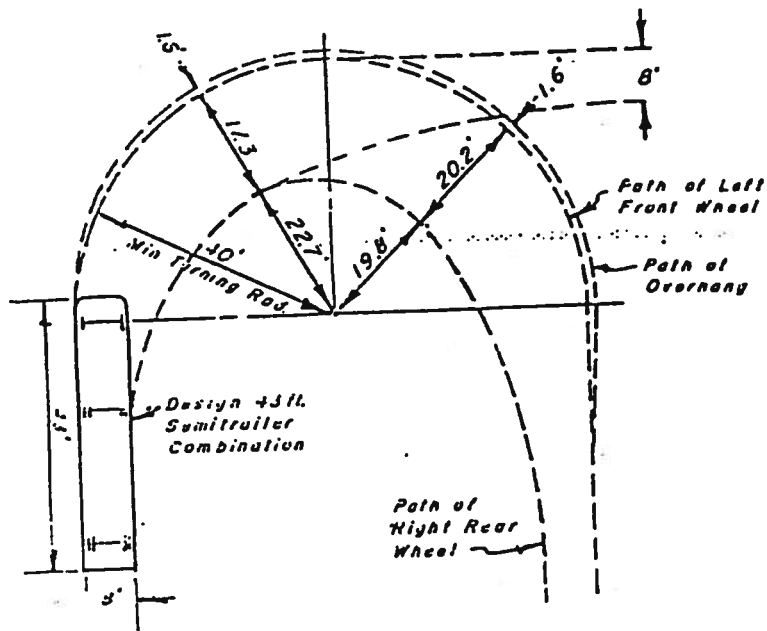

43 ft. SEMITRAILER COMB.
DESIGN VEHICLE (3)

SCALE 1" = 30'

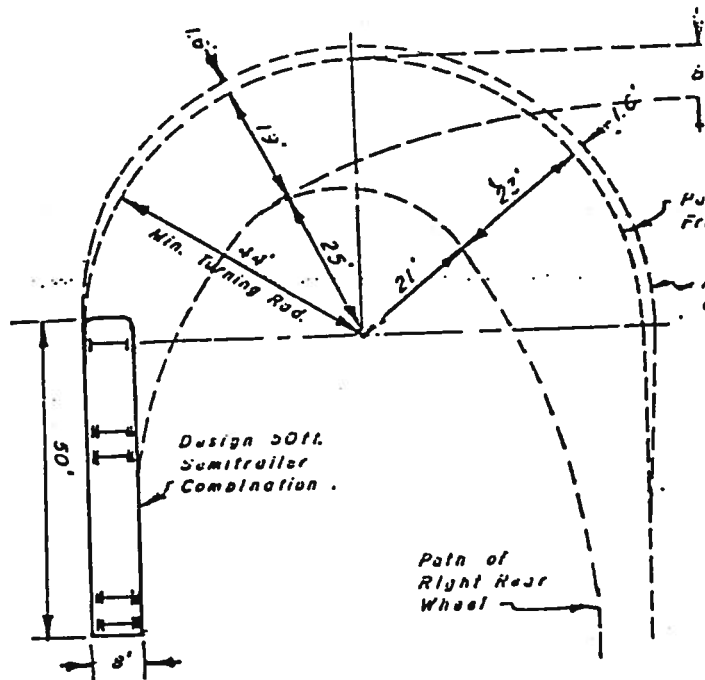

50 ft. SEMITRAILER COMB.
DESIGN VEHICLE (4)

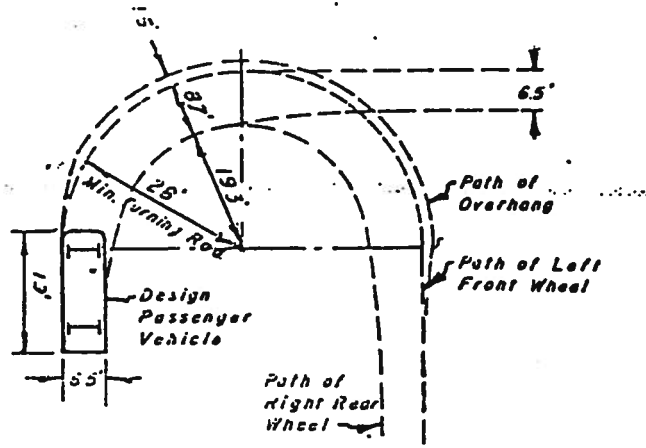

PASSENGER
DESIGN VEHICLE (1)

SCALE 1" = 30'

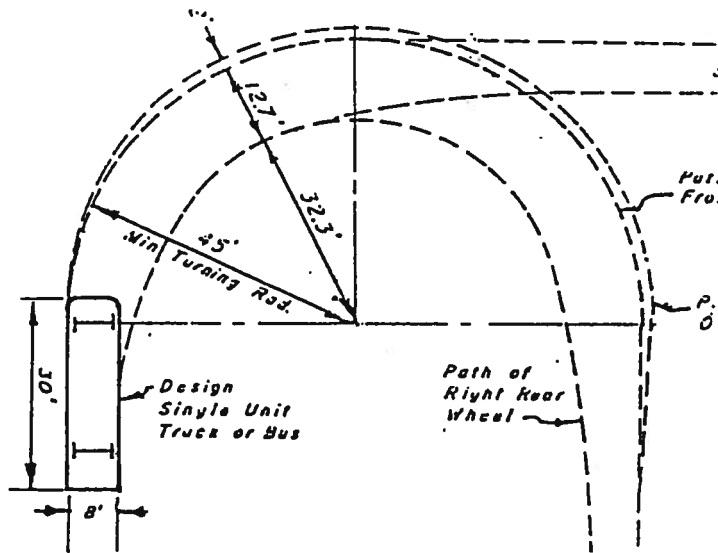

SINGLE UNIT TRUCK or BUS
DESIGN VEHICLE (2)

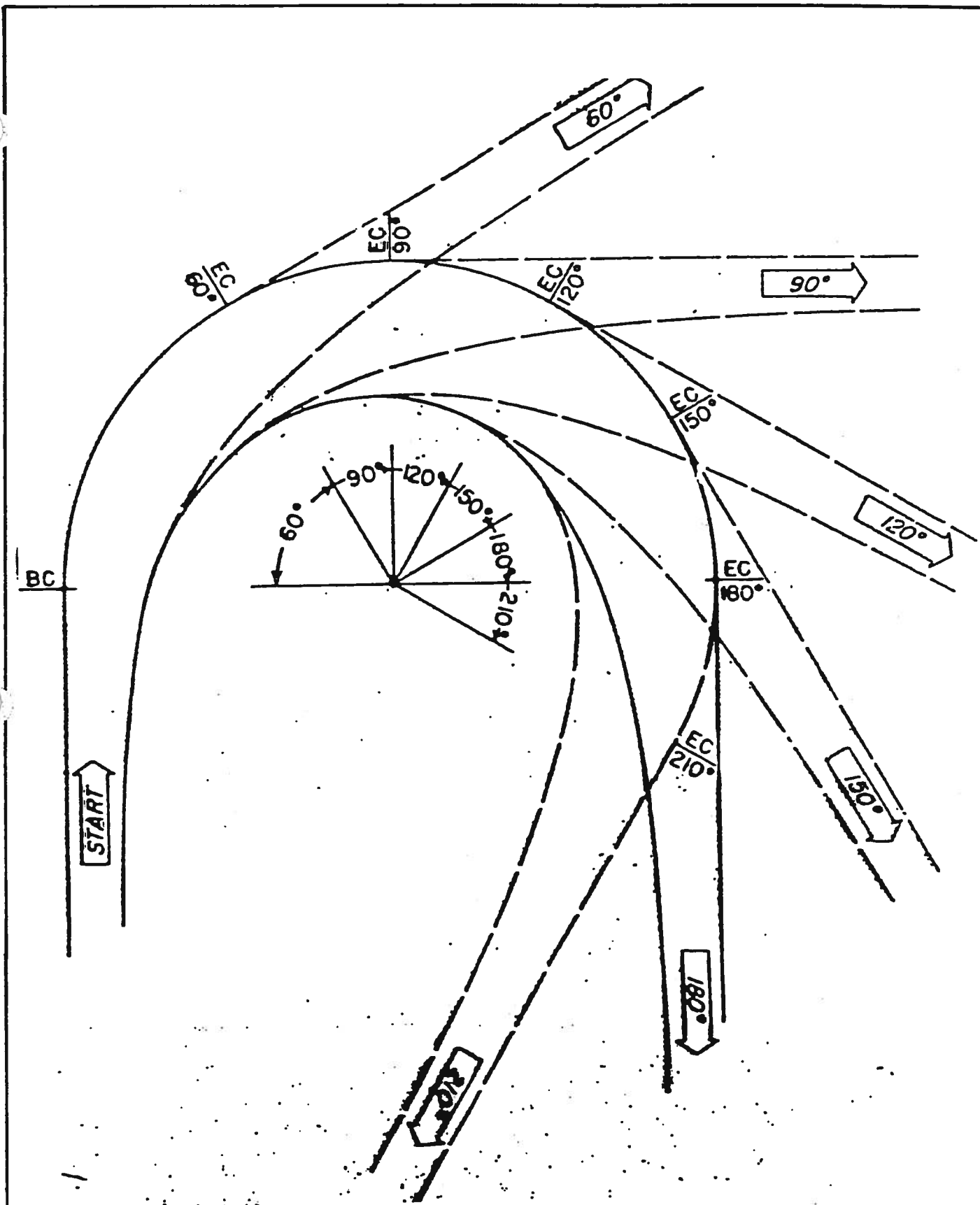

SEMITRAILER WHEEL TRACKS
48' RADIUS

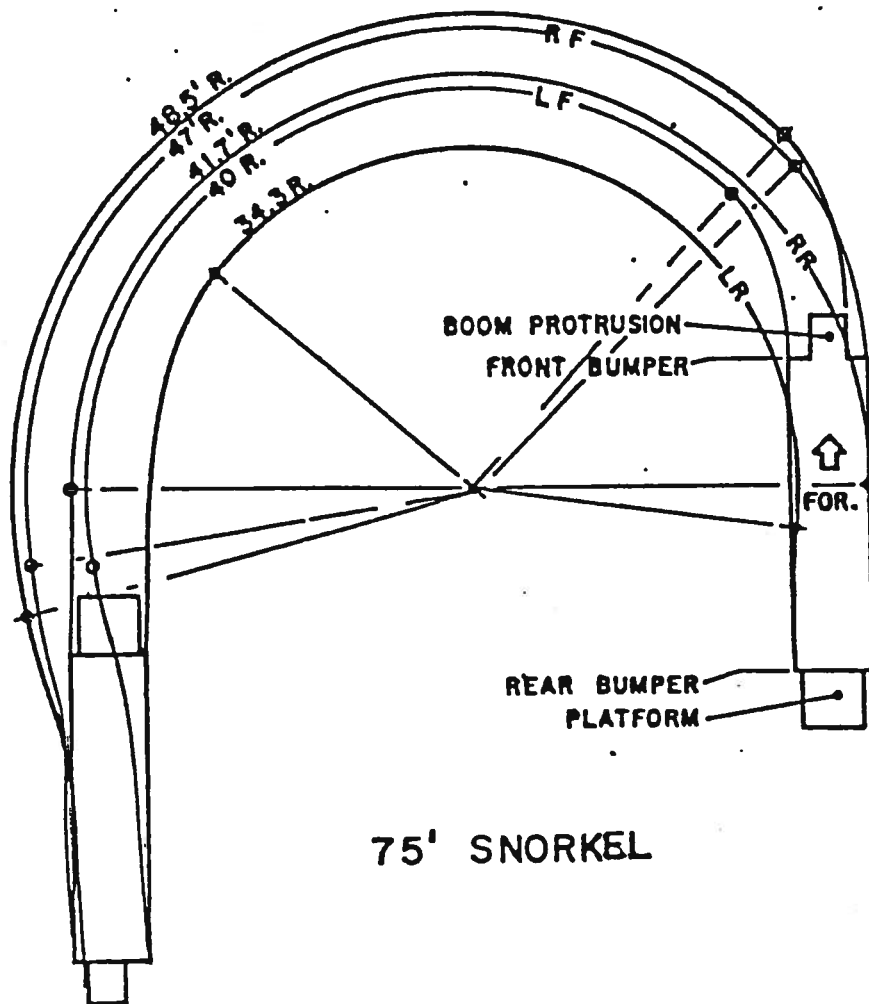

75' SNORKEL

Scale 1"=20'

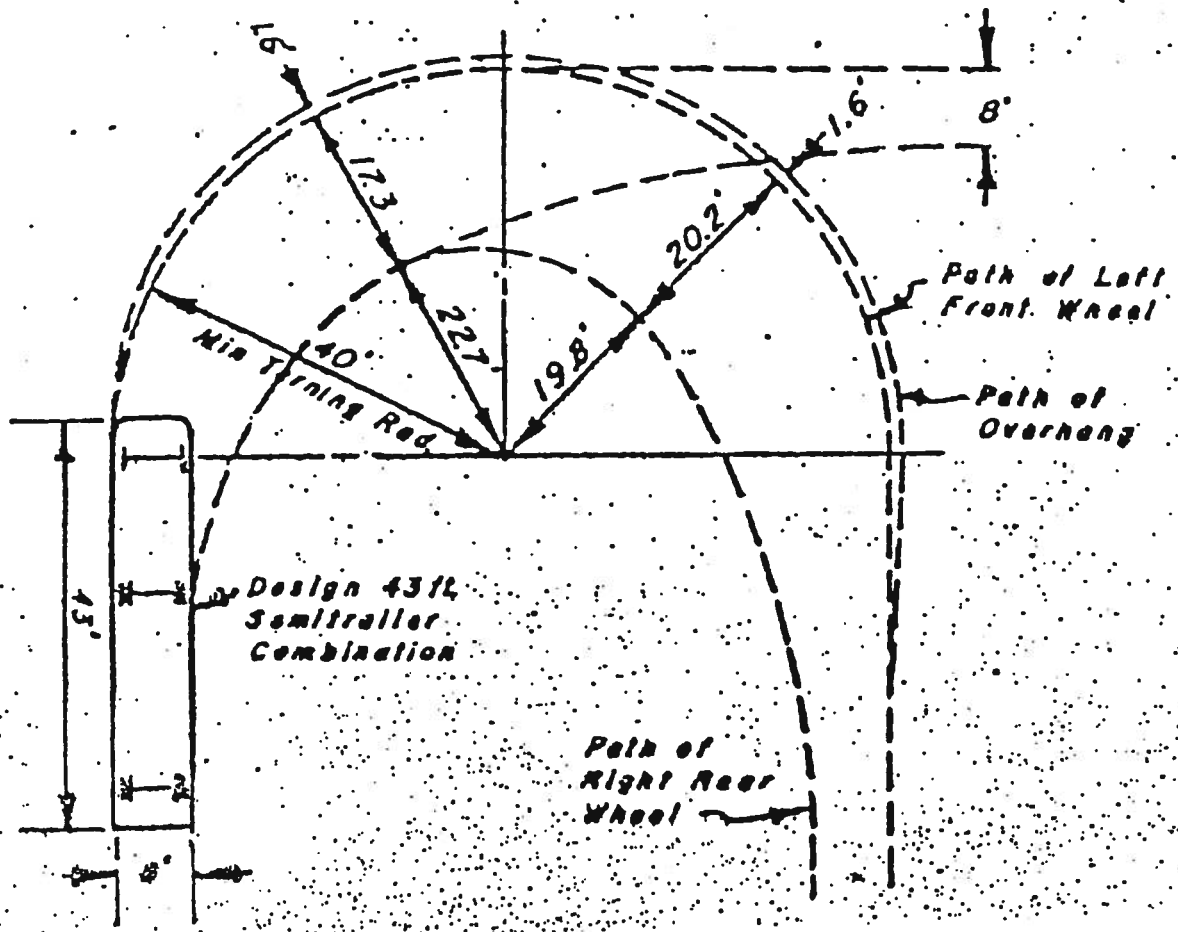

SINGLE UNIT TRUCK or BUS
DESIGN VEHICLE (3).

SCALE 1" = 20'

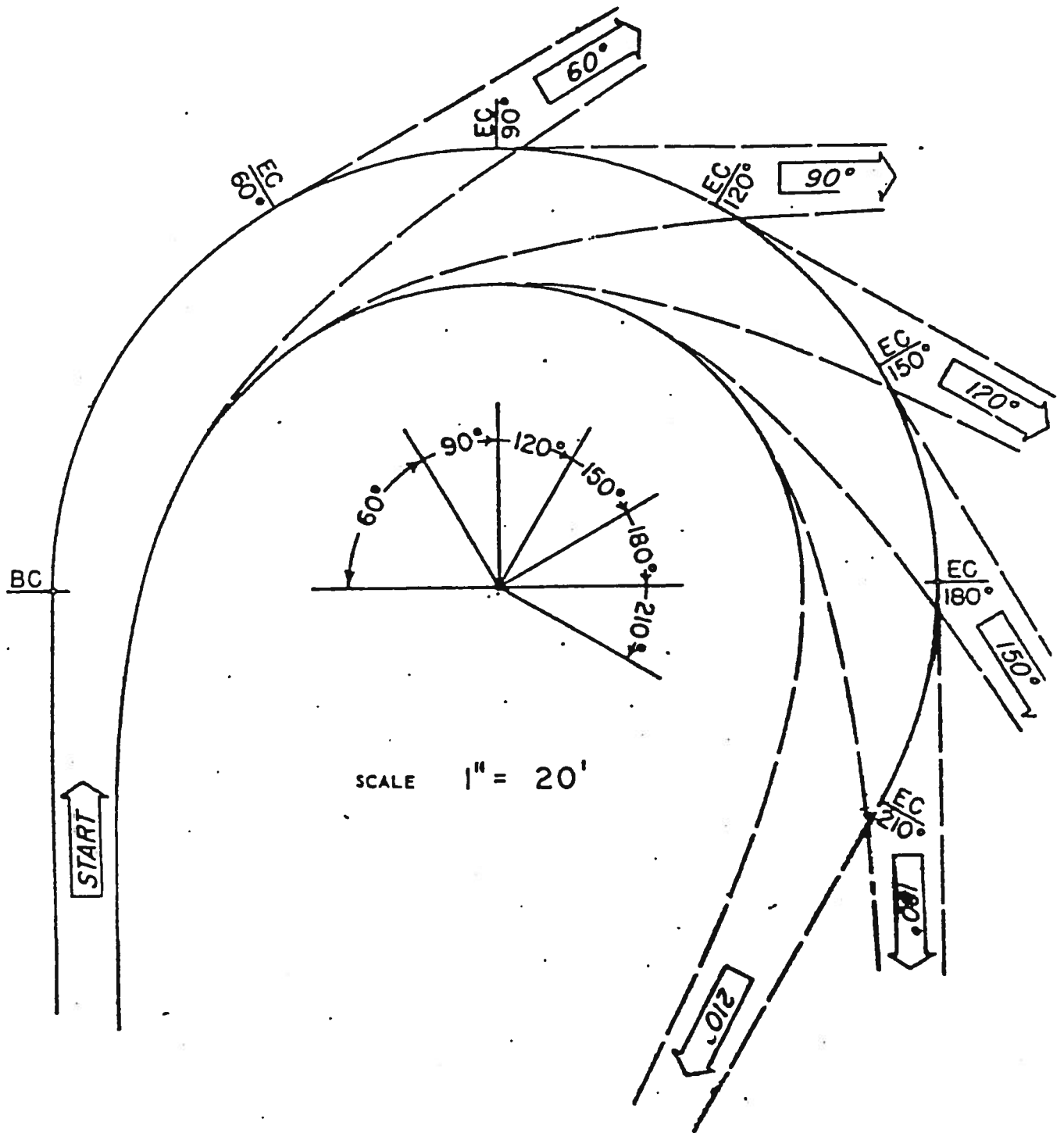

SEMITRAILER WHEEL TRACKS
58' RADIUS

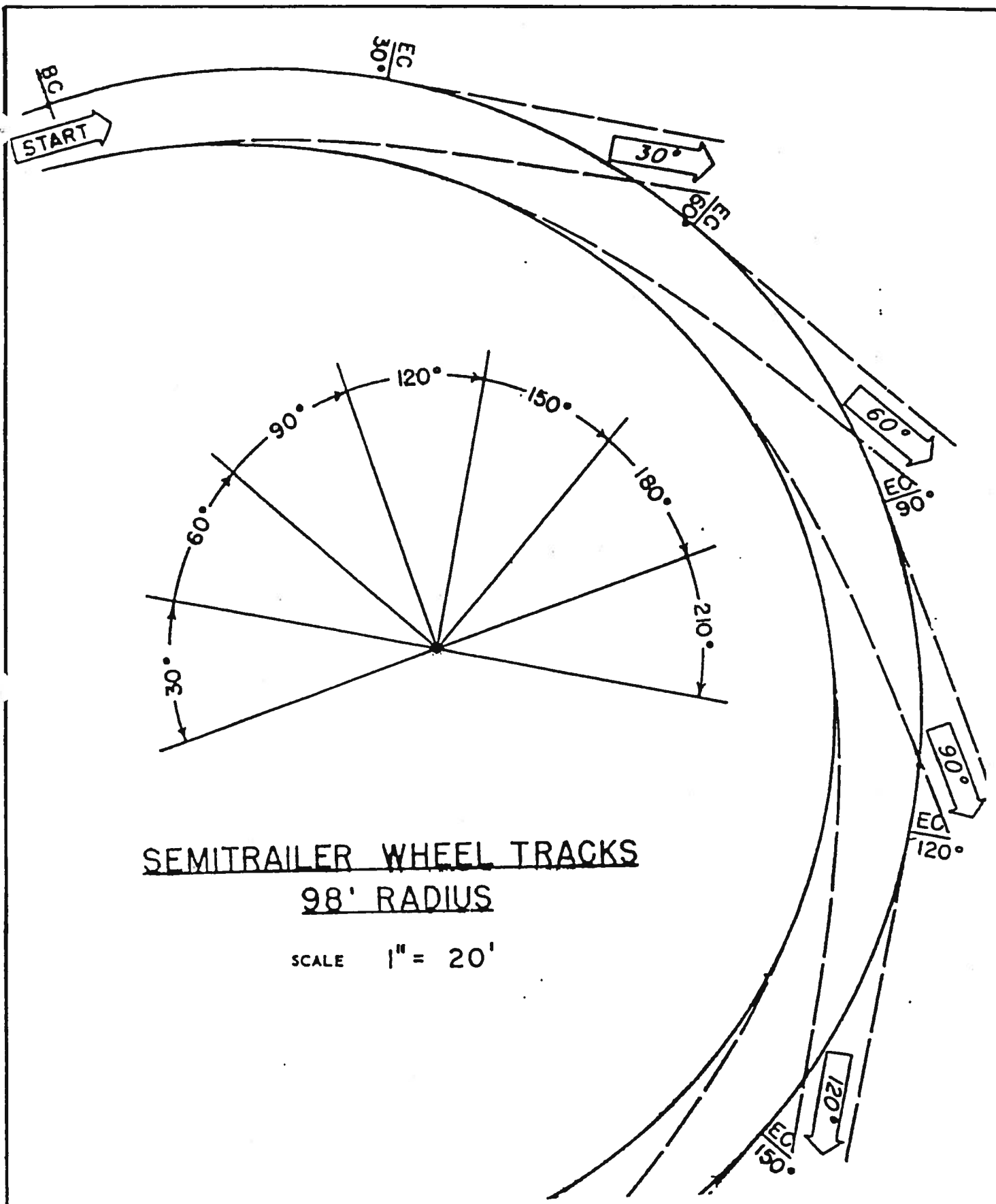

SEMITRAILER WHEEL TRACKS

98' RADIUS

SCALE 1" = 20'

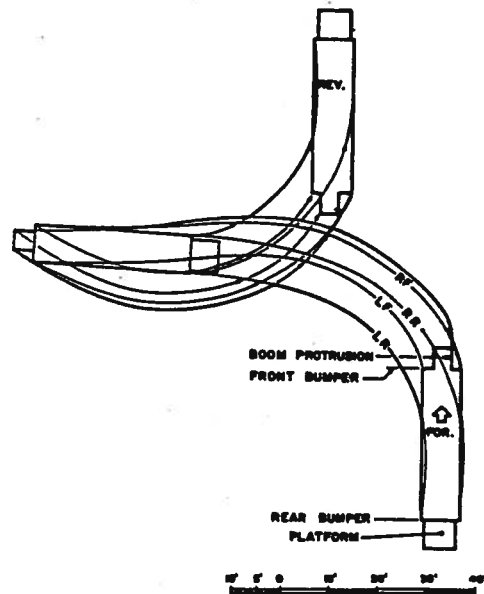
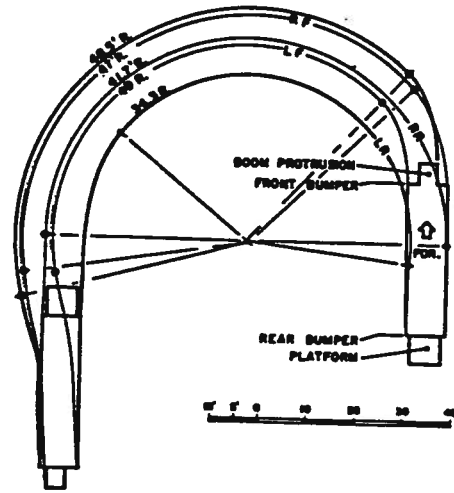
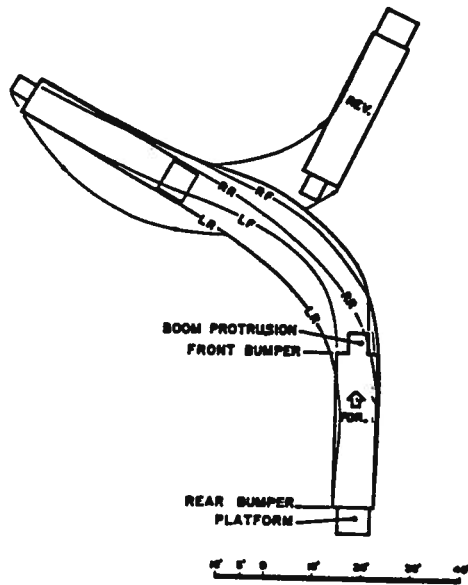

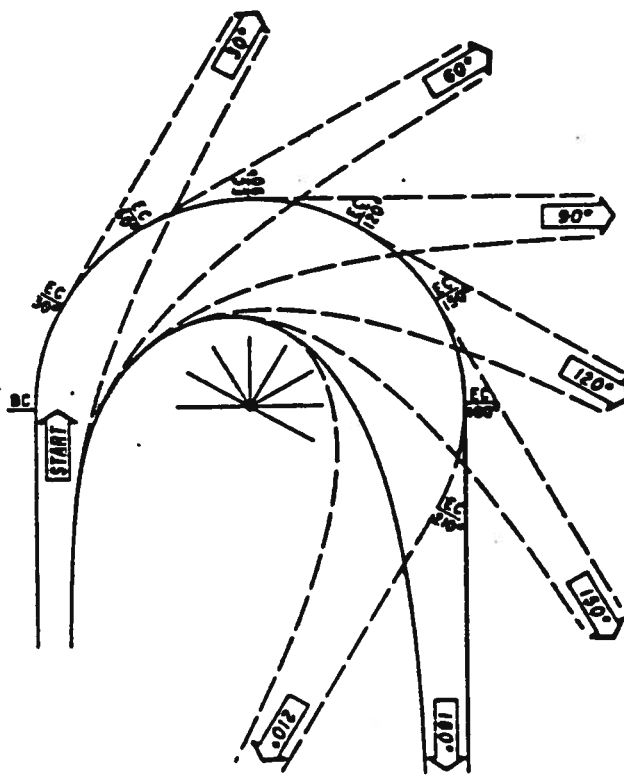

COLLECTED COURTESY OF UNIVERSITY
 TRANSPORTATION RESEARCH BOARD OF THE U.S. DEPARTMENT OF
 TRANSPORTATION
SEMITRAILER WHEEL TRACK

SCALE IN FEET
 0 20 40 60

40' Scale
 48
 48' TURNING RADIUS

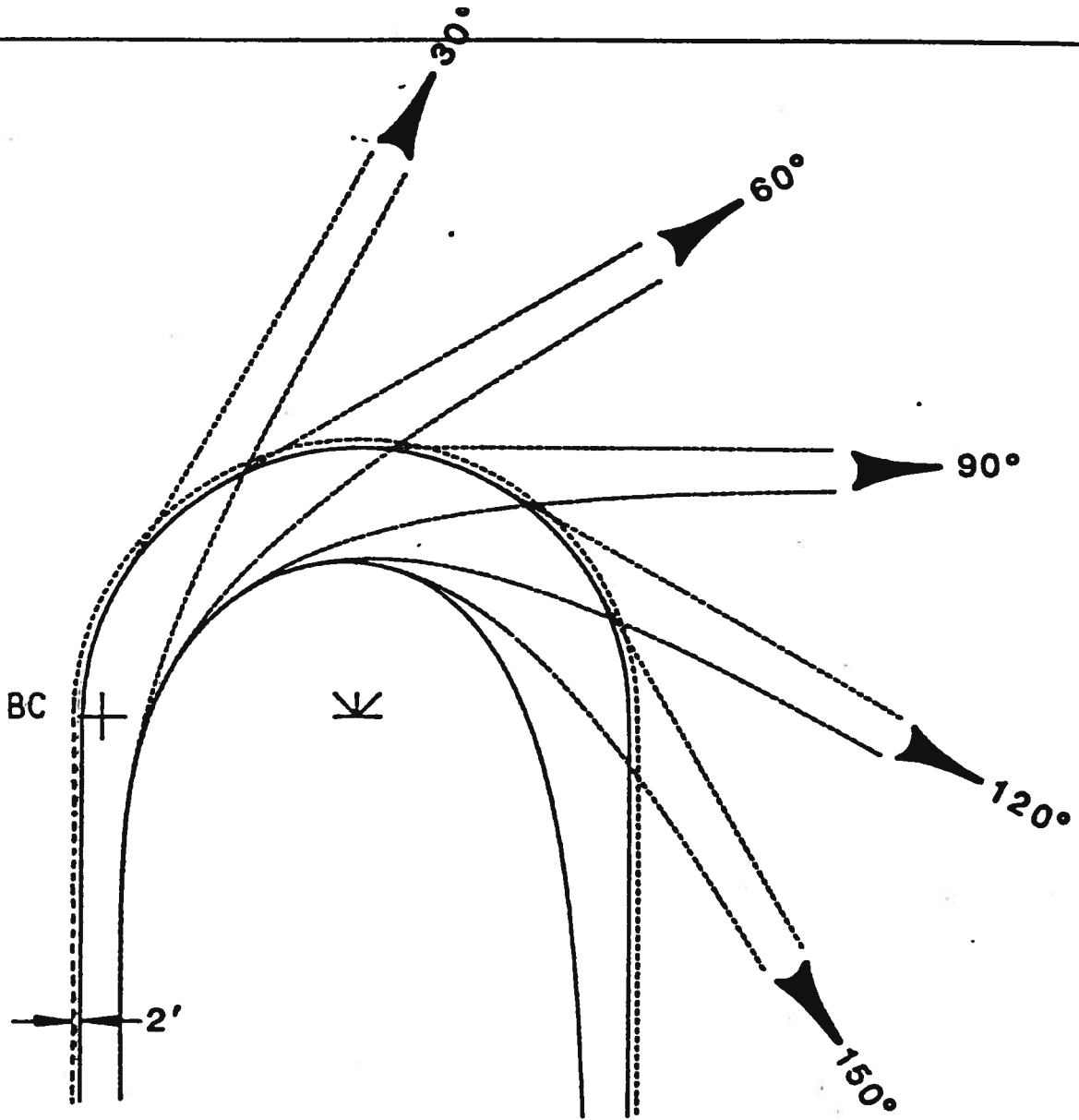

**CALIFORNIA TRUCK
SEMITRAILER WHEEL TRACKS**

SCALE IN FEET



60' TURNING RADIUS
TRAFFIC ENGINEERING POLICY TE No.14

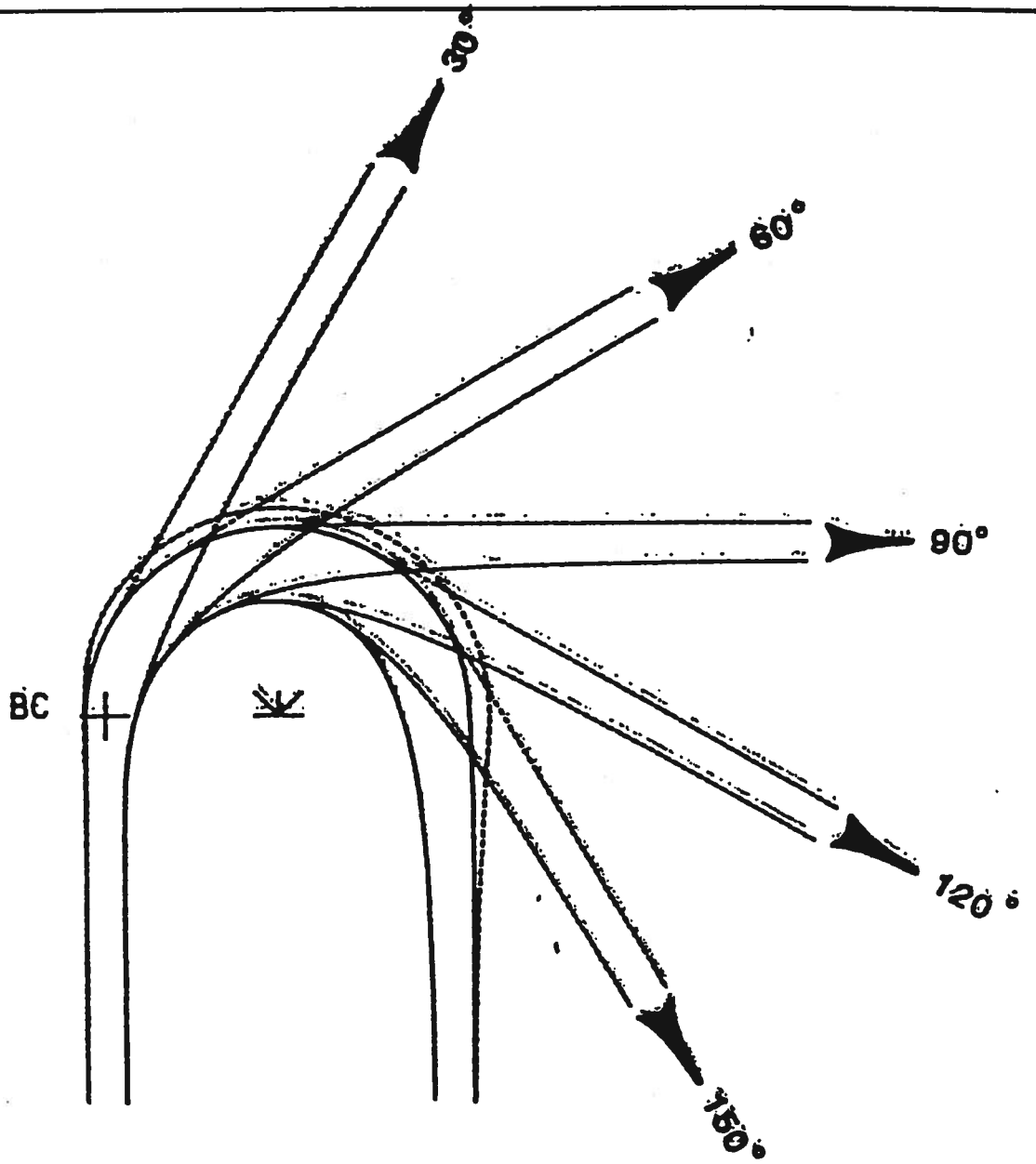

BUS WHEEL TRACKS

SCALE IN FEET



42' TURNING RADIUS
 TRAFFIC ENGINEERING POLICY TE No.14

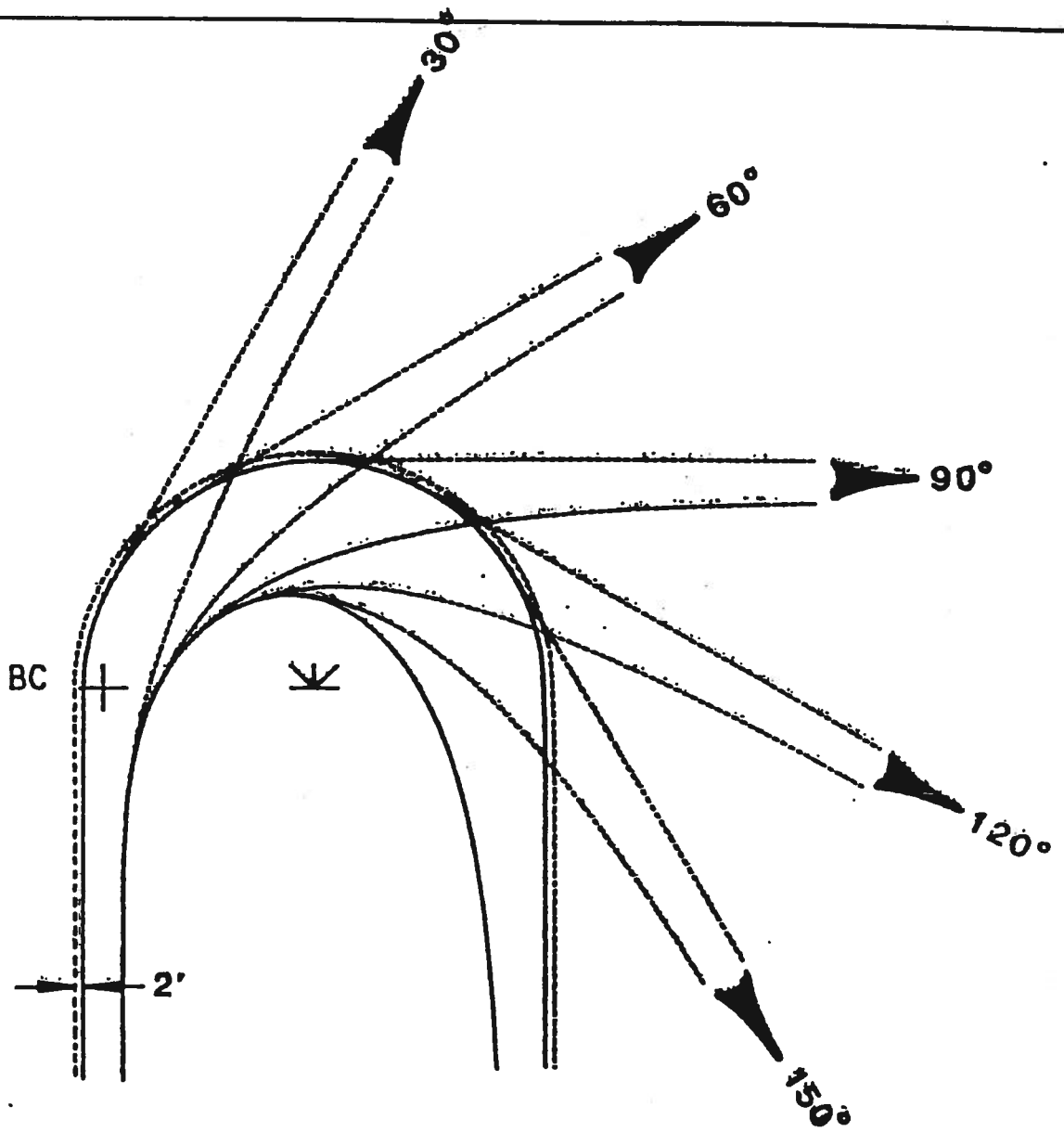

**CALIFORNIA TRUCK
SEMITRAILER WHEEL TRACKS**

SCALE IN FEET



50' TURNING RADIUS
TRAFFIC ENGINEERING POLICY TE No.14

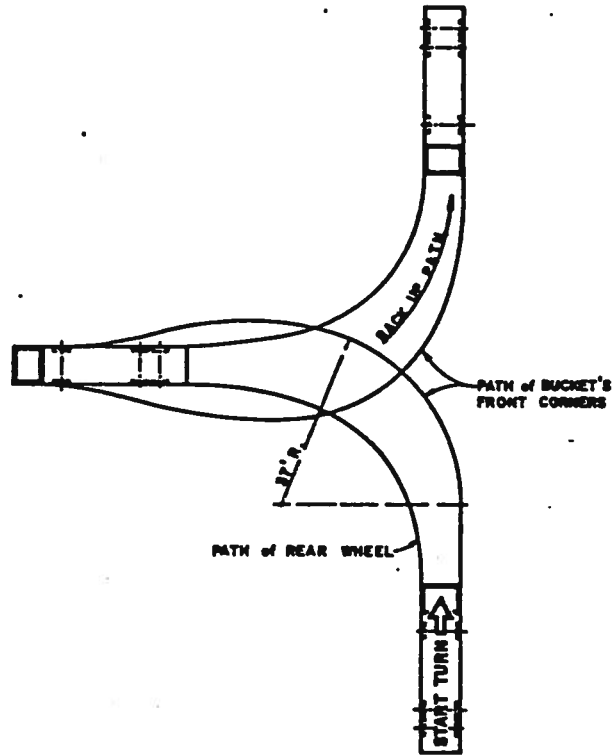

VEHICLE MINIMUM TURNING PATHS

Scale 1" = 40'

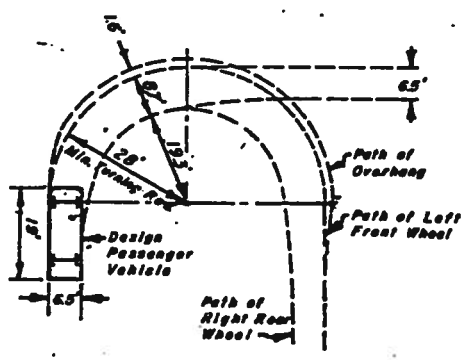

**PASSENGER
DESIGN VEHICLE (1)**

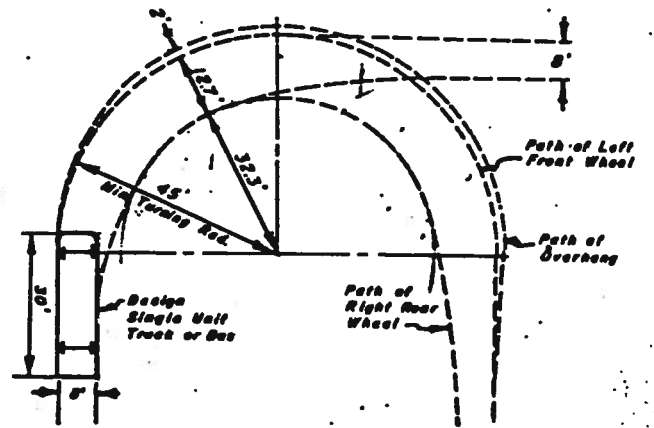

**SINGLE UNIT TRUCK or BUS
DESIGN VEHICLE (2)**

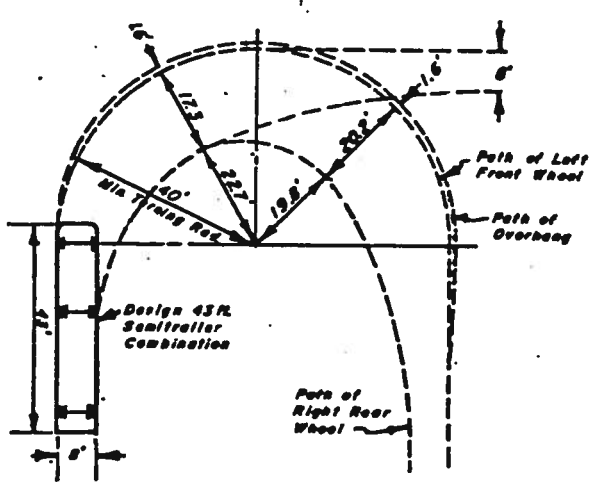

**43ft. SEMITRAILER COMB.
DESIGN VEHICLE (3)**

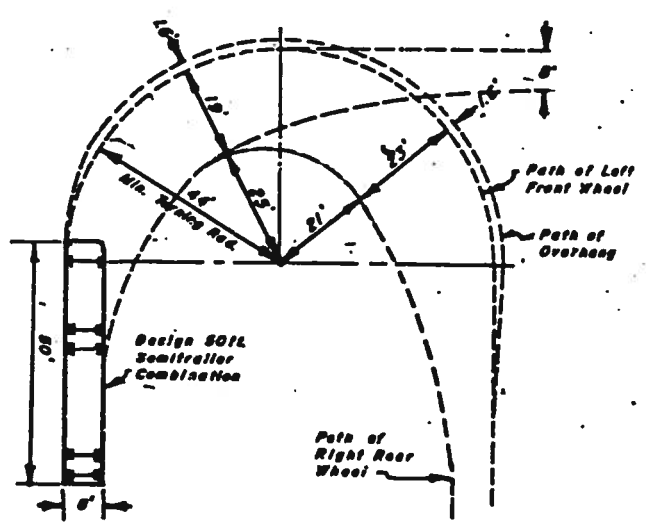

**50ft. SEMITRAILER COMB.
DESIGN VEHICLE (4)**

(1) - A.A.S.H.O. Designation = P

(2) - A.A.S.H.O. Designation = S.U.

(3) - A.A.S.H.O. Designation = C-43

(4) - A.A.S.H.O. Designation = C-50

1" = 40'

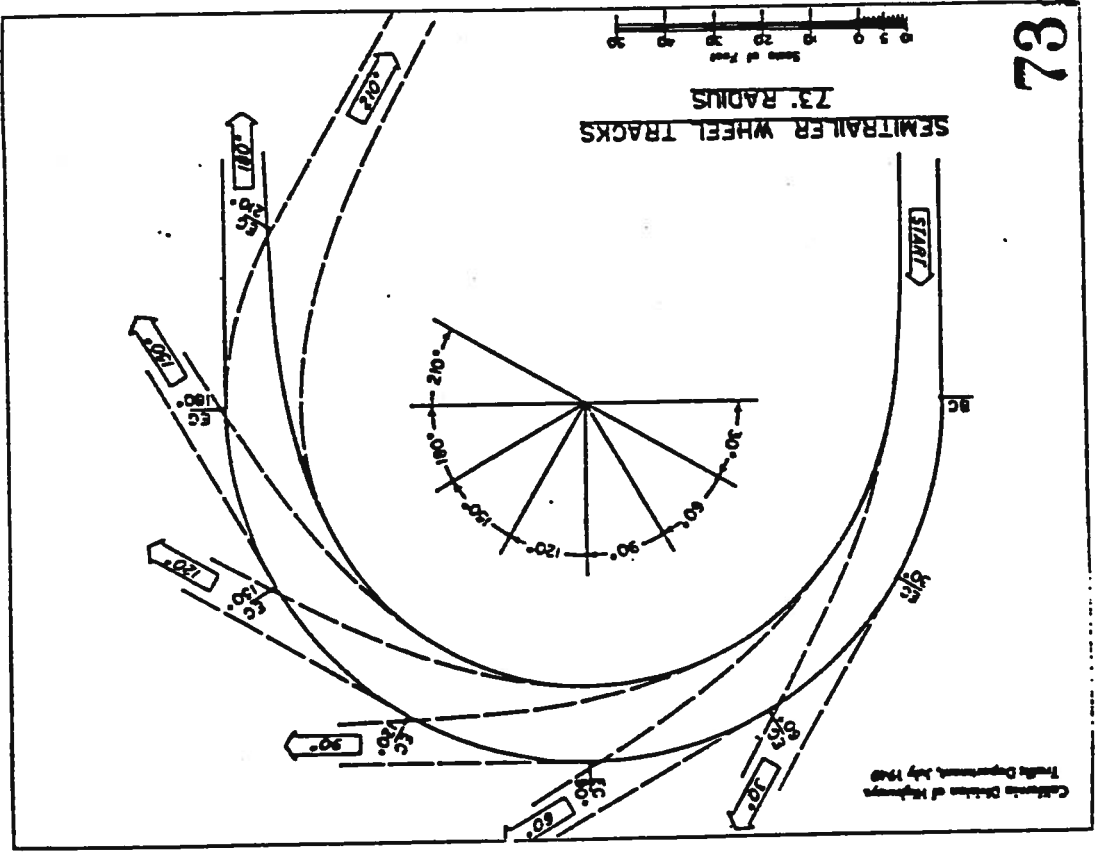

73

1" = 40'

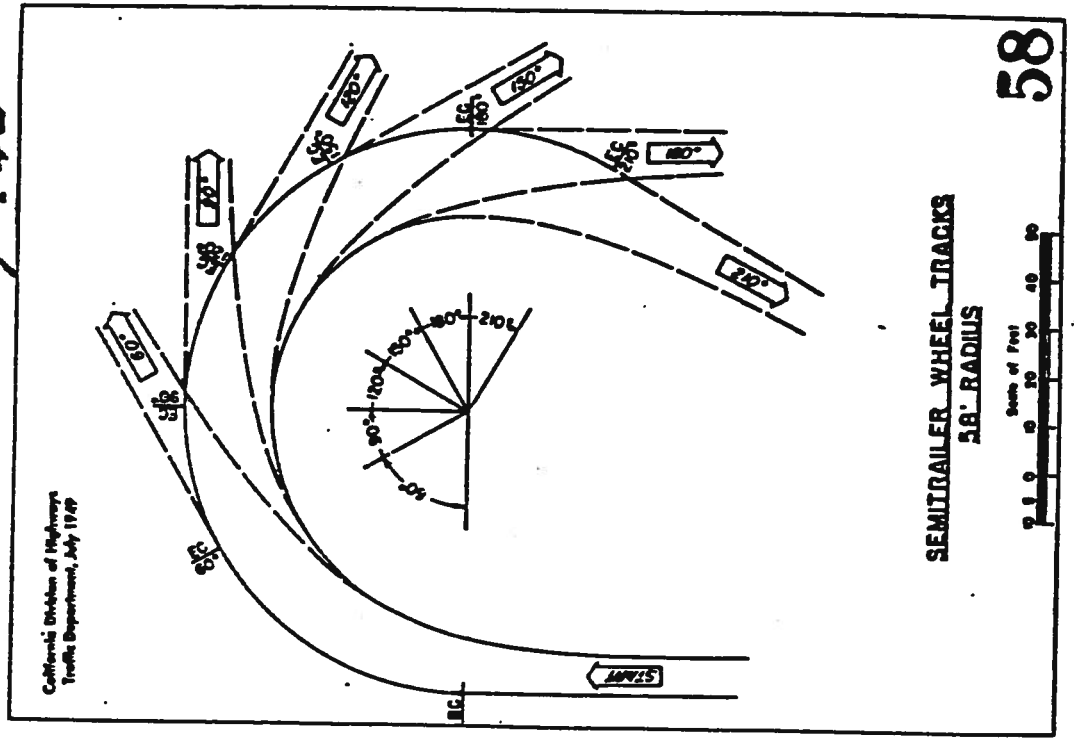

58

